

LOCTITE®

Loctite® Maintenance, Repair & Overhaul Solutions Guide & Product Selector





MAKING THE RIGHT CHOICE...

For every industrial maintenance, repair and overhaul challenge, Loctite® products have the right solution.

Designed to prevent common failures, extend equipment life and increase production reliability, the Loctite® product range is a maintenance professionals most valuable tool. Proven with over 50 years industrial experience, typical product applications include;

- ✓ Securely lock any threaded fastener or fitting against vibration and shock load.
- ✓ Seal and protect threaded joints and components.
- ✓ Instantly replace gaskets of any size or shape.
- ✓ Retain bearings, bushes and cylindrical parts into housings or onto shafts - even if worn.
- ✓ Protect metal parts from corrosion, galling and seizing.
- ✓ Permanently and quickly bond a wide variety of materials.
- ✓ Make emergency repairs to burst pipes and tanks.
- ✓ Clean, degrease and covert rust.

MORE THAN A PRODUCT...

Our highly experience Loctite® Application Engineers are committed to providing the highest level of technical and product support in the industry.

Working closely with our local industrial suppliers, our Application Engineers provide full process support from problem solving to on-site maintenance and product training.



Within this Solutions Guide & Product Selector you will find everything you need to know about Loctite® brand industrial grade products. Whether for an emergency repair or preventative maintenance, you will find it easy to select the Loctite® product you need. However if more information is required, all you have to do is visit our website or call the Loctite® Customer Support Line.



1300 88 555 6
www.loctite.com.au



09 272 6710
www.loctite.co.nz



WHAT'S INSIDE...

<input type="checkbox"/>	Committed to Innovation	5
<input checked="" type="checkbox"/>	Threadlocking	6–9
<input checked="" type="checkbox"/>	Thread Sealing	10–13
<input checked="" type="checkbox"/>	Gasketing	14–17
<input checked="" type="checkbox"/>	Retaining	18–21
<input checked="" type="checkbox"/>	Anti-Seize Lubricants	22–25
<input checked="" type="checkbox"/>	Bonding	26–27
<input checked="" type="checkbox"/>	Primers and Activators	28–29
<input checked="" type="checkbox"/>	Rust Treatment and Cleaning	30–31
<input checked="" type="checkbox"/>	Kit and Emergency Repair	32–33
<input type="checkbox"/>	Technical References	35–43
	<i>Ten Points About Liquid Threadlockers</i>	35
	<i>Loctite at Work</i>	36–37
	<i>Application Procedures</i>	38–40
	<i>Agency Approvals</i>	41
	<i>Fluid Compatability Chart</i>	42–43

LOCTITE®

THE MASTER OF MOBILITY

Mobility comes in many forms and Loctite Sticks provide improved mobility to make your job faster and easier. Loctite Sticks are convenient enough to carry in your pocket and perfect for use in hard to reach or overhead applications without any drips, leaks or spills.

NO LEAKS, DRIPS OR SPILLS
FITS IN YOUR POCKET
KEEPS TOOLBOXES AND HANDS CLEAN
FAST AND EASY TO APPLY
GREAT FOR OVERHEAD USE



248 Medium Strength
Threadlocker



268 High Strength
Threadlocker



668 High Temp/Strength
Retaining Compound

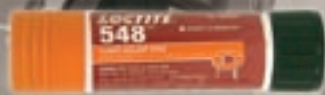

548 Gasket Eliminator™
Flange Sealant



534 Hi-Tack Gasket Tack
and Sealant



561 PST™ Pipe Sealant
with PTFE

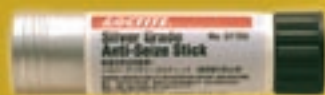

Silver Grade Anti-Seize Stick





COMMITTED TO INNOVATION

From its founding in 1953, based on the world's first anaerobic product that cured in the absence of air, Loctite® has achieved success through innovation.

An unrelenting commitment to continuous research and development has resulted in the most technically advanced range of industrial maintenance products available today. Products that increase equipment reliability, reduce costs and improve quality throughout industry.

Here are some of our newest innovations featured throughout this catalogue;

Loctite® Sticks

The quality and performance you trust in a new and more convenient semi-solid stick formula.

These patented new stick products offer greater flexibility for tougher applications, especially overhead, under or around machinery, and on components that can not be moved. They're compact, making them easy to carry from job to job and easy to store in a tool box, tool belt or pocket. The semi-solid formula means that they won't spill or leak. Now available in an expanded range including two threadlockers, a pipe sealant, an anti-seize, a retaining compound and two gasketing products.

Loctite® Reliability with a twist!

(Refer to previous page for more details)



Primerless Threadlockers

Formulated with ground-breaking technology, and designed to achieve rapid fixture strength without the use of primers, Loctite® Primerless Threadlockers cure up to 400% faster than conventional products and are ideal for work sites where flammable primers are restricted. Available in two grades, 2440 Medium Strength and 2760 High Strength, they also feature broad chemical resistance. *(Refer to page 9 for more details).*



Loctite® Freeze & Release

The solution for releasing seized or corroded parts – SHOCK FREEZE.

Loctite® Freeze & Release instantly chills seized and rusted parts (bolts, nuts, studs) down to -43°C. The exceptional shock-freeze effect causes microscopic cracks in the layer of rust, allowing the lubricating ingredient to wick directly into the rust by capillary action. The assembly can be easily dismantled after allowing 1-2 minutes reaction time. Released parts remain lubricated and protected from corrosion. *(Refer to page 25 for more details).*





Threadlocking



Invented as a revolutionary method to lock and seal threaded fasteners, Loctite® brand anaerobic threadlockers have found wide acceptance in a range of applications – from delicate electronic components to heavy construction equipment. Loctite® brand threadlockers are available in varying viscosities and strengths for virtually any application, including exposure to extreme environments.

Features & Benefits

Prevents Loosening of Fasteners - Sets to a thermoset plastic that fills microscopic gaps between interfacing threads preventing any movement.

Seals Against Corrosion – Seals the joint preventing ingress of moisture and other corrosive gases, chemicals and fluids.

Provides Correct Lubricity – Lubrication properties yield controlled torque tension curves - ideal for assembly of equipment to specified torque values.

Controlled Strengths – Available in varied controlled strengths to suit all applications – low, medium and high.

Suitable for all Fastener Sizes – Eliminates the need to hold stock of expensive mechanical fasteners.

Easy to Apply – Simply apply to the thread and assemble. Excess will not cure and can be easily wiped away.



Did You Know?

How does an Anaerobic Adhesive work?

Anaerobic adhesives are single-component materials which cure at room temperature when deprived of contact with oxygen. Curing begins when the two metal parts are mated together and any adhesive outside of the joint or thread remains liquid.

The capillary effect of the anaerobic liquid adhesive carries it into even the smallest gaps to fill the joint. The cured adhesive is then 'keyed' to the surface roughness of the parts forming a tough thermoset plastic, which bonds the components and seals against moisture or chemical attack.

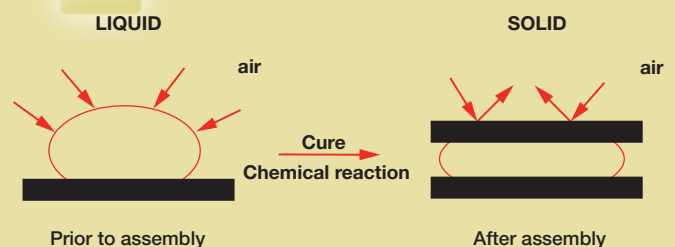



Threadlocking

Product Selector

1 Are the parts assembled?

2 What strength is required?

3 Maximum Temperature

4 Unique Features

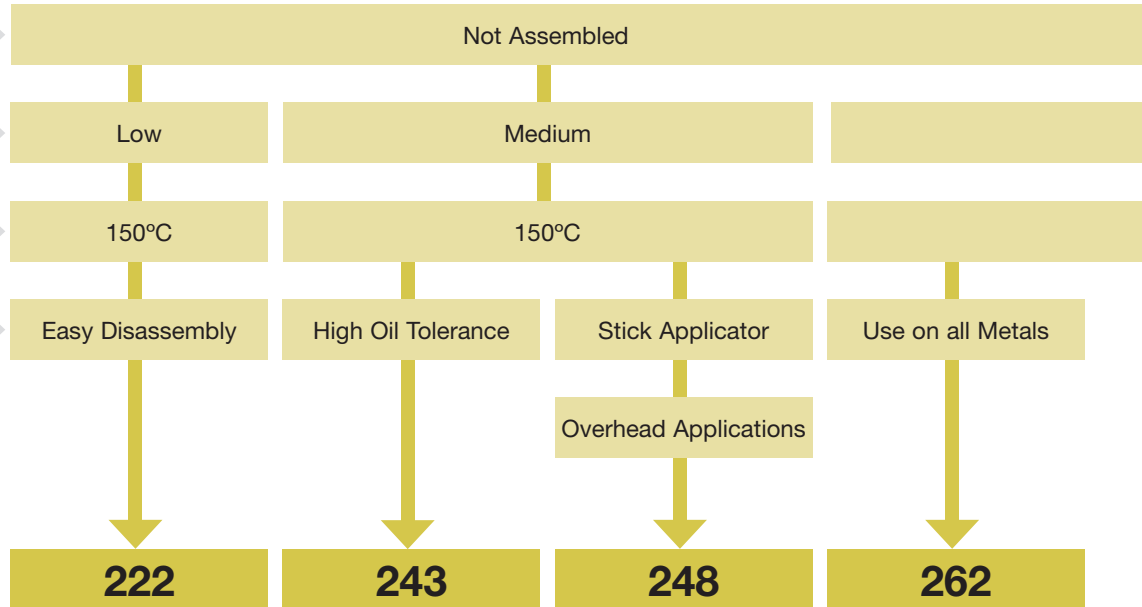

Solution

	222	243	248	262
Fastener Size	Up to 36mm (M36)	Up to 36mm (M36)	Up to 20mm (M20)	Up to 36mm (M36)
Colour	Purple	Blue	Blue	Red
Strength	Low	Medium	Medium	High
Fixture Time [#]	20 min	20 min	10 min	20 min
Full Strength [#]	24 hrs	24 hrs	24 hrs	24 hrs
Breakloose Torque [#] Nm (lb.in.)	14 (120)	24 (210)	20 (177)	38 (340)
Prevailing Torque [#] Nm (lb.in.)	14 (120)	24 (210)	-	40 (350)
Temperature Range	-54°C to +150°C	-54°C to +150°C	-54°C to +150°C	-54°C to +150°C
Recommended Activator	7471	7471	7649	7649
Disassembly Method	Hand Tool	Hand Tool	Hand Tool	Direct Heat
Size (Part Number)	10ml bottle (22220) 50ml bottle (22250) 250ml bottle (22270)	10ml bottle (21320) 50ml bottle (21321) 250ml bottle (21322)	19gm stick (37773B)	10ml bottle (26220) 50ml bottle (26250) 250ml bottle (26270)

[#] M10 steel nut & bolt, cured for 24 hours @ 22°C and pre-torqued to 5Nm. * Breakaway torque. For further information refer to product Technical Data Sheet.

Product Description



Loctite® 222



Recommended for low strength threadlocking of adjusting screws, counter sunk head screws and set screws; on collars, pulleys, tool holders, and controllers.

Loctite® 243



Effective on all types of metal threaded fasteners. Prevents loosening on vibrating parts such as pumps, motor mounting bolts, gear boxes or presses. Contains a cutting additive for high oil tolerance.

Loctite® 248



Medium strength semi-solid stick applicator ideal for hard to reach applications. Recommended for fastener applications where removal is required.

Loctite® 262



For use on all metal fasteners (including stainless steel and those with protective coatings such as zinc), where permanent locking and sealing is required.

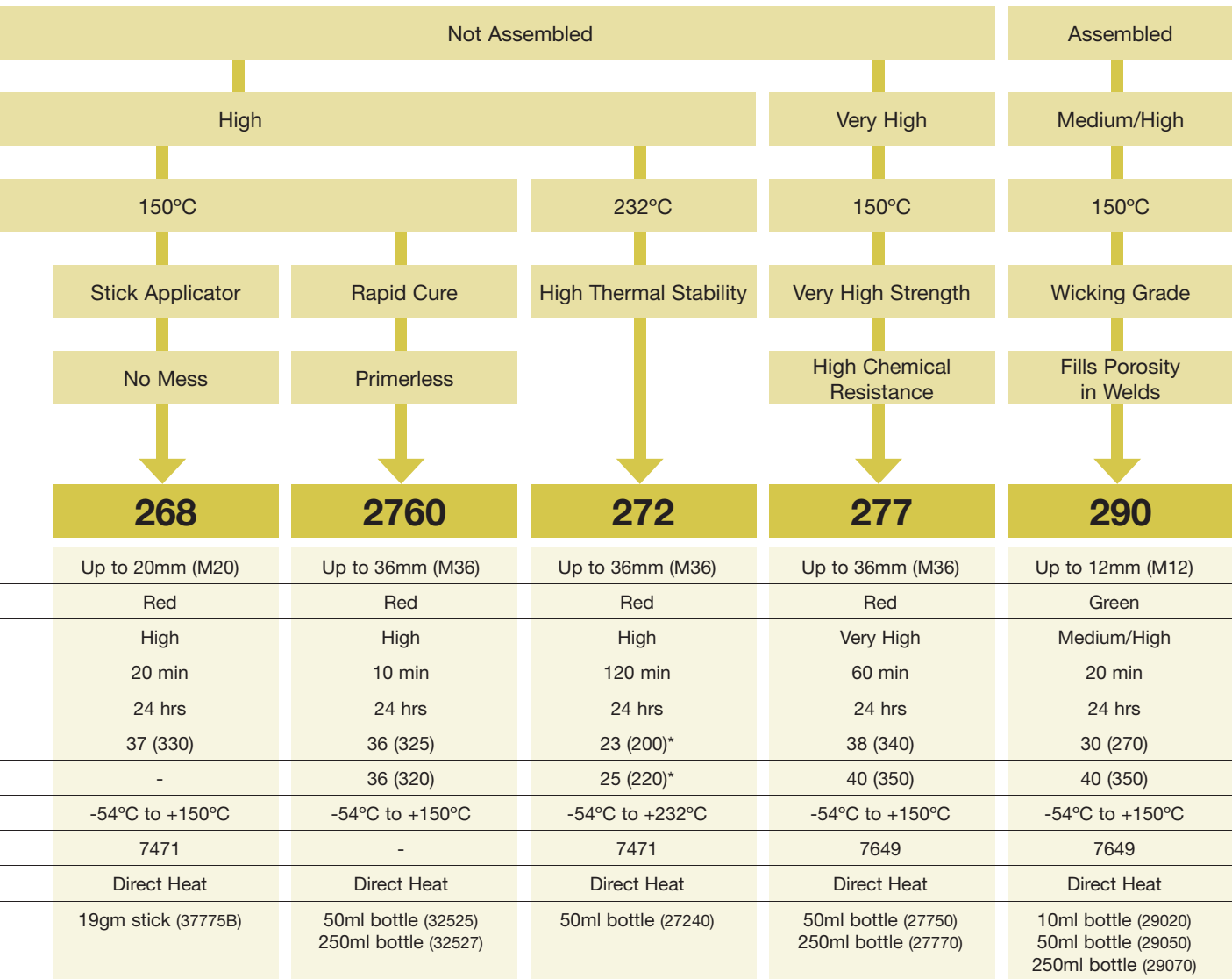

Loctite® 268

Loctite® 2760

Loctite® 272

Loctite® 277

Loctite® 290



High strength semi-solid stick applicator ideal for hard to reach places. Recommended for heavy duty applications such as transmission bolts and construction equipment.



Achieves rapid cure without primers. Ideal for sites such as mines where flammable primers are restricted. Also available in medium strength – Loctite® 2440 50ml (33947) or 250ml (33948)



High temperature threadlocker with outstanding chemical resistance. Suitable for sealing most refrigerants.



Very high strength threadlocker with outstanding chemical resistance. Suitable for sealing most refrigerants.



Recommended for locking pre-assembled fasteners such as instrument screws, electrical connectors and set screws.



Thread Sealing



Loctite® brand liquid thread sealants seal and secure metal pipes and fittings, filling the space between threaded metal parts and curing to prevent leakage. Designed for low and high pressure applications, liquid thread sealants seal instantly for low pressure testing. When fully cured, they seal to the burst strength of most piping systems.

Features & Benefits

Complete Seal – Fills voids between threads creating a 100% seal, preventing leakage caused by vibrational loosening, temperature cycling, corrosion and extreme pressures.

Locks & Seals in any Position – Seals independent of assembly torque allowing correct alignment of fittings.

Does Not Block Pipe System – Uncured anaerobic sealant is completely soluble in hydraulic fluid, diesel oils, petrols and most industrial chemicals.

Instant Low Pressure Seal – Suitable for immediate operation or low pressure testing of newly sealed threads.

Lubricates During Assembly – Eliminates risk of over-stressing fittings or castings, common with alternative thread sealing methods.

Easy Application & Disassembly – Simply apply directly to the thread and assemble. Excess sealant can be wiped away without solvents or chemicals. Disassembled with hand tools.

Replaces most tapes and hemp/paste combinations.



Did You Know?

Industry loses millions of dollars annually due to leakage of fluids through pipe and tubing. Loctite® brand sealants prevent fluid loss, minimising cost of wastage, maintenance and down-time.

The table below details the significant potential cost of a leaking hydraulic fitting over a one year period.

Leakage Rate	Loss per Day (ltr)	Loss per Year (ltr)	Annual Cost (\$/Year)
One drop in 10 sec.	0.56	204.98	\$1,025
One drop in 5 sec.	1.12	409.97	\$2,050
One drop per sec.	5.62	2049.84	\$10,250

Based on Hydraulic Fluid: \$5.00 / litre



Thread Sealing

Product Selector

1 Are the pipe threads metal or plastic?

Plastic (or Metal & Plastic)

2 What will flow through pipes?

Water only

Hydraulic

3 Will operating pressure exceed 300kPa?

Yes (Above 300kPa)

No (Below 300kPa)

4 Are the threads fine or coarse?

Fine - up to 19mm (3/4")

5 What approvals are required?

Potable Water/Gas

Potable Water/Gas

Gas

6 Unique Features

Allows Back off to Align Fittings

Hot & Cold Water

Will not contaminate critical assemblies

Solution

55

5331

569

Description	Cord	White Paste	Brown Liquid
Maximum Thread Size	100mm (4")	76mm (3")	19mm (3/4")
Instant Low Pressure Seal	Yes	Yes (up to 50kPa)	No
Temperature Range	-54°C to +150°C	-54°C to +150°C	-54°C to +150°C
Disassembly Strength	Low	Low	Low/Medium
Recommended Activator	-	-	7471
Size (Part Number)	50m (37371A) 150m (31899)	100ml tube (23872)	50ml bottle (56950) 250ml bottle (56970)

For further information refer to product Technical Data Sheet.

Product Description

Loctite® 55



Faster, more versatile pipe sealant which out-dates traditional tapes and hemp/pastes combinations. Provides an instant seal and allows back-off to align fittings.

Approvals

- Plumbing Safety License AS/NZS 4020:2002 Cert No. 8638 (Potable Water)
- AGA Certificate 6007 to 2400kPa (Gas).

Loctite® 5331 No More Leaks



Recommended for use on low pressure threaded plastic or plastic/metal fittings carrying hot or cold water.

Approvals

- German DVGW No 96.07e125 (Gas & Potable Water)
- German KTW (Potable Water)
- WRC approved to 85°C (Potable Water)

Loctite® 569



Recommended for fine threaded fittings as used in hydraulic and pneumatic applications.

Approvals

- AGA Certificate 3375 to 1050kPa (Gas)



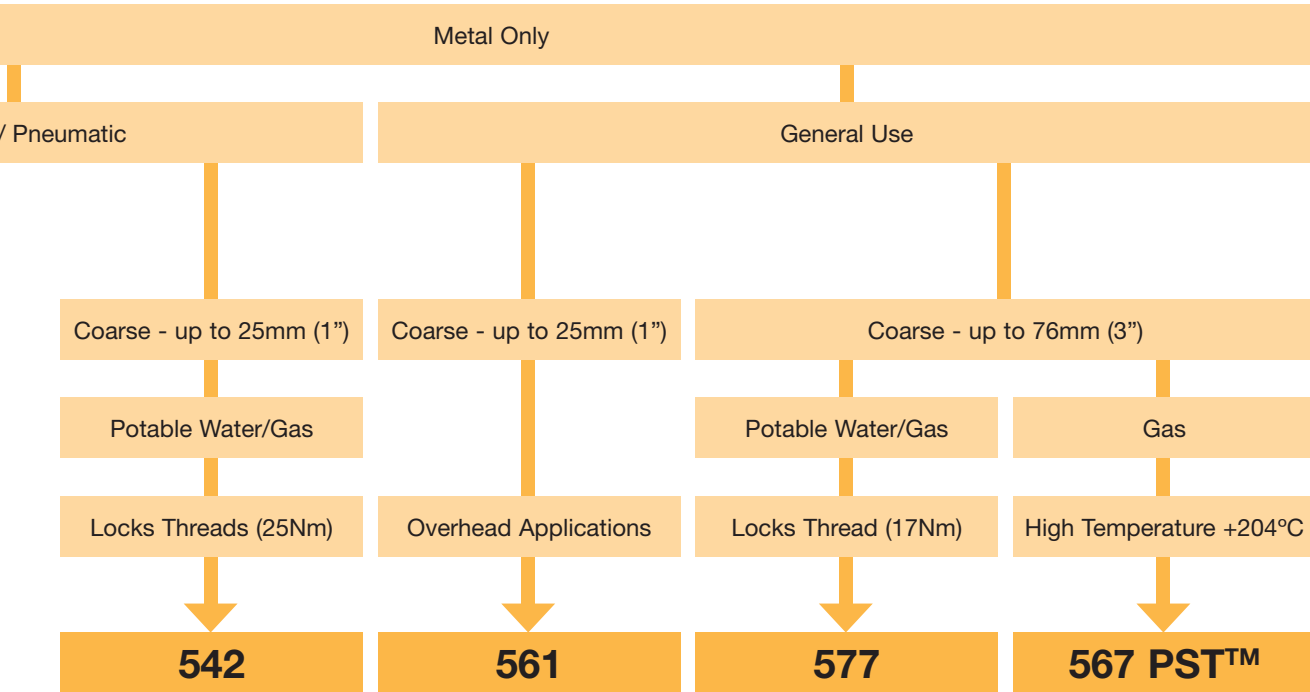

Brown Liquid	White Stick	Yellow Paste	White Paste
25mm (1")	25mm (1")	76mm (3")	76mm (3")
No	Yes	Yes	Yes
-54°C to +150°C	-54°C to +150°C	-54°C to +150°C	-53°C to +204°C
Medium	Medium	Medium/High	Low/Medium
7471	7649	7471	7649
10ml bottle (25344) 50ml bottle (54266)	19gm stick (37776B)	50ml tube (19259) 250ml tube (34112)	6ml tube (56707) 50ml tube (56747A) 250ml tube (26741)

Loctite® 542



Recommended for threaded fittings as used in hydraulic and pneumatic installations.

Approvals

- German DVGW No 96.02e125 (Gas & Potable Water)
- BS 6956 Type A (Gas)
- WRC approved to 85°C (Potable Water)

Loctite® 561



Semi-solid stick formula offers added convenience and portability. Formulated for fast, reliable curing on metal, tapered pipe threads and fittings. Provides high pressure sealing at operating temperatures up to 150°C.

Loctite® 577



Recommended for all coarse metal threads. Suitable for applications at low temperatures requiring fast cure.

Approvals

- Plumbing Safety License AS/ NZS 4020:2002 Cert No. 20079 (Potable Water)
- AGA Certificate 4787 to 2600kPa (Gas)

Loctite® 567 PST™



Recommended for all coarse metal threads where slow cure is required to prolong time frame for adjusting valves and fittings.

Approvals

- AGA Certificate 3207 to 1050kPa (Gas)



Gasketing



Loctite® brand Anaerobic and Silicone gasketing solutions are suitable for small and large gap flange assemblies. Formed-in-place, they can be applied to any shape and offer improved seal reliability compared to traditional pre-cut compression gaskets.

Features & Benefits

Anaerobic Gaskets

Loctite® brand anaerobic gaskets remain liquid when exposed to air, but cure when confined between mating flanges. Anaerobic gasketing products are best suited for small gap applications and rigid metal-to-metal assemblies.

Features and Benefits;

- ✓ No Shimming Effect - controlled tolerances, no need for re-torquing.
- ✓ Fills all voids reducing the need for a fine surface finish on flanges.
- ✓ Does not shrink when cured.
- ✓ Parts can be easily disassembled even after extended service.
- ✓ Resists high pressure when fully cured.

Silicone Sealants

Loctite® brand silicone gasketing materials include unique products with excellent fluid and high temperature resistance. They are best suited for large gap applications and stamped metal assemblies where flange flexing occurs.

Features and Benefits;

- ✓ High gap fill and flexibility.
- ✓ High temperature and chemical resistance.



Did You Know?

What is a Formed-In-Place Gasket?

Formed-in-place gaskets are applied as a fluid sealant to one of the flange surfaces before the parts are assembled. When the parts are assembled the sealant spreads between the flanges, filling gaps, voids, scratches and surface irregularities. After assembly the gasket cures and forms a durable seal.

Formed-in-place gaskets eliminate the inventory expense of stocking countless pre-cut gaskets.

How do you remove baked-on gasket material?

Loctite® 790 Chisel® Gasket Remover easily removes pre-cut gasket cement and formed-in-place gaskets in 10-15 minutes. Simply spray on, then wipe or scrap off residual gasketing material. (Refer to page 31 for further details).

How do you position and seal pre-cut gaskets?

Loctite® 534 Hi-Tack Gasket Dressing & Sealant Stick is designed to hold pre-cut gaskets in place while assembling and helps to seal up to +150°C.



Gasketing

Product Selector

1 What size is the gap?

Less than 0.5mm (Anaerobic Sealants)

2 Is the flange rigid or flexible?

Rigid (Metal to Metal)

3 What is the flange material?

Steel

Alloy/Aluminium

All Metals

4 Maximum Temperature

150°C

150°C

150°C

200°C

5 Unique Features

Use with Shims

Easy Disassembly

Stick Applicator

High Chemical Resistance

Solution

515

518

548

510

Gasket Type	Formed in Place	Formed in Place	Formed in Place	Formed in Place
Flange Type (Elongation)	Rigid	Rigid	Rigid	Rigid
Tack Free Time [#]	-	-	-	-
Low Pressure Seal	30 min	30 min	-	2 hrs
Temperature Range	-54°C to +150°C	-54°C to +150°C	-54°C to +150°C	-54°C to +200°C
Oil Resistance	Excellent	Excellent	Excellent	Excellent
Water/Glycol Resistance	Good	Good	Good	Excellent
Sensor Safe	Yes	Yes	Yes	Yes
Neutral Cure	-	-	-	-
Recommended Activator	7649	7649	7471	7471
Size (Part Number)	6ml tube (51517) 50ml tube (51531A) 300ml cartridge (33530)	6ml tube (51817) 25ml syringe (51827) 50ml tube (25583A) 300ml cartridge (51845)	18gm stick (40393B)	50ml tube (25555A) 250ml tube (25554)

[#] Varies with substrate. For further information refer to product Technical Data Sheet.

Product Description



Loctite® 515



Recommended for coating and re-using gaskets to improve sealing.

Approvals

- AGA certificate 2590 to 690kPa (Gas)

Loctite® 518



Recommended for use on rigid iron, steel and aluminium flanges e.g. aluminium gearbox and engine castings, etc.

Loctite® 548



Semi-solid stick formula, ideal for on-the-spot repairs, or when a conventional gasket is out of stock. Can be applied quickly and neatly on a variety of metal surfaces to form a flexible, solvent resistant seal.

Loctite® 510



Recommended for use on rigid metal parts e.g. cast iron components and pump housings, etc. operating at high temperatures.

Approvals

- AGA certificate 2590 to 690kPa (Gas)

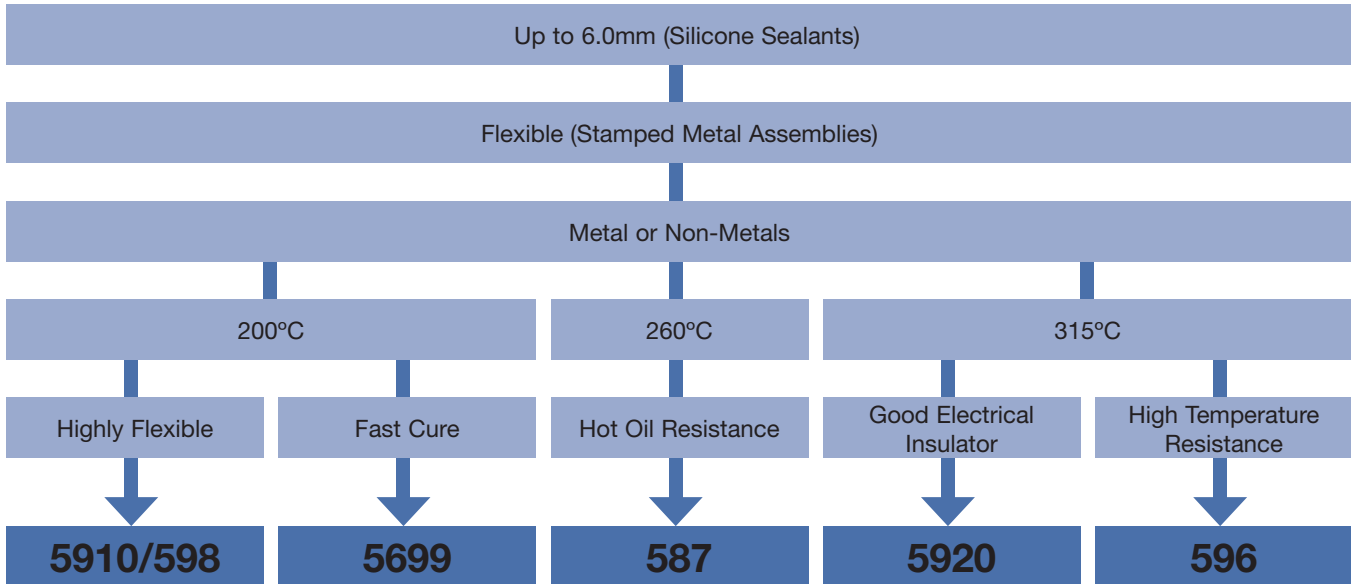

Formed in Place	Formed in Place	Formed in Place	Formed in Place	Formed in Place
Flexible (400%)	Flexible (100%)	Flexible (350%)	Flexible (350%)	Flexible (300%)
20 min	30 min	45 min	60 min	30 min
20 min	20 min	45 min	30 min	30 min
-54°C to +200°C	-60°C to +200°C	-60°C to +260°C	-60°C to +315°C	-60°C to +315°C
Excellent	Good	Excellent	Good	Good
Good	Good	Good	Good	Good
Yes	Yes	Yes	Yes	Yes
Yes	Yes	Yes	Yes	No
-	-	-	-	-
50ml syringe (39306) 95gm tube (39145)	95gm tube (34238) 420gm cartridge (18581A)	95gm tube (34848) 370gm cartridge (34888)	85gm tube (34249)	80ml tube (59630) 300ml cartridge (59675)

Loctite® 5910/598
Black Maxx®



Replacement for cork and paper cut gaskets on flanges and stamped sheet metal covers. Recommended for use where high vibration or flexing occurs. Can also be used with plastic parts. Oxygen sensor safe.

Loctite® 5699
Grey Maxx®



Designed for high torque applications. Remains flexible and withstands high vibration. Outstanding oil and shop fluid resistance. Non-corrosive, low odour.

Loctite® 587
Blue Maxx®



Recommended for sealing all types of flanges including stamped sheet metal where high flexibility and high oil or water glycol resistance is required. Oxygen sensor safe.

Loctite® 5920
Copper Maxx®



Single component RTV non-sag silicone paste for low volatility applications. Adheres to metal, glass, natural and synthetic fibres, wood, ceramics, and many plastic substrates. Oxygen sensor safe.

Loctite® 596
Superflex Red



Recommended for sealing all of flanges including stamped sheet metal where high temperature resistance is required, e.g. assembly and repair of industrial furnaces, ovens, boilers, exhaust stacks and high temperature ducting.



Retaining



Accepted as a standard method for assembling press and slip parts, Loctite® anaerobic retaining compounds fill the ‘inner space’ between components and cure to form a strong precision assembly. Formulated in a wide variety of viscosities, gap fills, flexibility and strength characteristics, Loctite® anaerobic retaining compounds are suitable for a broad range of industrial maintenance applications.

Features & Benefits

Increased Assembly & Product Reliability – Prevents damage caused by press or shrink fits such as wallowing, backlash and fretting corrosion.

Fills all Voids & Ensures 100% Contact – Fills infinite microscopic imperfections that exists on even the most precisely machined surfaces, thereby providing 100% contact between mating parts, ensuring load and stress is distributed evenly over the joint.

Creates Stronger Industrial Assemblies – Increases shear strength of mechanical assemblies and is suitable for a wider range of industrial applications from securing a metal locating pin to large diameter shaft bearings.

Seals Against Corrosion – Seals the assembly preventing ingress of moisture and other corrosive gases, chemicals and fluids.

Replaces or Augments Mechanical Assemblies - Reduces need for close tolerances, additional securing components and elaborate assembly methods, therefore reducing maintenance cost.

Controlled Strengths – Available in high & moderate strengths formulations to suit all applications. Parts can be disassembled using regular processes.



Did You Know?

Interference fits typically have only 20-40% effective contact area!

Typically the contact area is limited to the peaks left behind by machining processes. Micro-movement during dynamic loading can shear these away, allowing the joint to fail. Tightening the machining tolerances to avoid this is a very expensive solution.

A Loctite® anaerobic retaining compound assures 100% contact, as well as eliminating “fretting corrosion” within the joint.

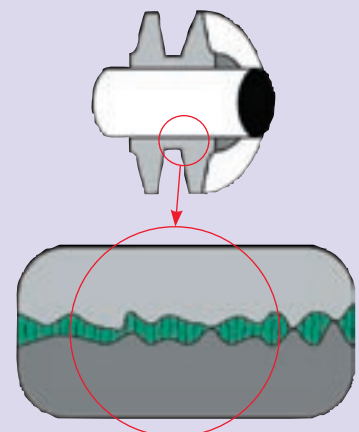

Loctite® brand Retaining Compounds fill the microscopic peaks and valleys, ensuring maximum adhesion between mating surfaces



Retaining

Product Selector

1 Is the assembly badly worn?

No (Gaps)

2 Do you require lubricity for interference fit?

No

3 What strength do you require?

Low

Medium

4 Maximum Temperature

150°C

150°C

200°C

5 Unique Features

Easy Disassembly

General Purpose

High Temperature

Solution

641

609

668

Colour	Yellow	Green	Green
Strength	Low	Medium	Medium
Fixture Time [#]	30 min	25 min	30 min
Full Strength [#]	24 hrs	24 hrs	24 hrs
Maximum Gap Fill Diameter	0.20mm	0.20mm	0.20mm
Compressive Shear Strength [#] N/mm ² (psi)	6.5 (940)	15.8 (2,300)	7.0 (1,015)
Temperature Range	-54°C to +150°C	-54°C to +150°C	-54°C to +200°C
Recommended Activator	7649	7471	7649
Disassembly Method	Pulley or Press	Press	Press
Size (Part Number)	10ml bottle (21314) 50ml bottle (21315) 250ml bottle (21316)	10ml bottle (30013) 50ml bottle (30015) 250ml bottle (30014)	19gm stick (40391B)

[#] Steel pin & collar, cured for 24 hours @ 22°C. * Steel pin & collar cured for 2 hours @ 121°C. For further information refer to product Technical Data Sheet.

Product Description



Loctite® 641



A controlled strength retaining compound, ideal for cylindrical parts that require disassembly; e.g. retention of bearings onto shafts and into housings.

Loctite® 609



Recommended as a general purpose, low viscosity retaining compound. Use to bond rotors to shafts, secure bushings and sleeves, and augment press fits.

Loctite® 668



High temperature retaining compound in a semi-solid formula. Featuring a no mess stick applicator, it is ideal for hard to reach and high temperature applications.

to 0.25mm)			Yes (Gaps to 0.5mm)
		Yes	No
High		Medium	High
150°C	232°C	150°C	150°C
Quick Cure	Very High Temperature	High Lubricity	Repairs Worn Parts
680	620	232	660
Green	Green	Brown	Silver
High	High	Medium	High
20 min	120 min	4-6 hrs	10 min
24 hrs	24 hrs	72 hrs	24 hrs
0.20mm	0.25mm	0.10mm	0.5mm
19.3 (2,800)	17.2 (2,495)	9.3 (1,350)*	17.2 (2,490)
-54°C to +150°C	-54°C to +232°C	-54°C to +150°C	-54°C to +150°C
7471	7649	7471/ 7649	7471
Press	Press	Press	Press
50ml bottle (68050) 250ml bottle (68070)	50ml bottle (62050) 250ml bottle (62070)	250ml bottle (27863)	6ml tube (66010A) 50ml tube (66040A)

Loctite® 680



Gives best resistance to dynamic, axial and radial loads. Recommended for retaining shafts, gears, pulleys, and similar cylindrical parts.

Approvals

- Plumbing Safety License 4020:2002 Cert No. 8687 (Potable Water)

Loctite® 620



Recommended for high temperature retaining of parts with a clearance or interference fit, e.g. retaining bushes, bearings, seals, fans and liners.

Loctite® 232



Has lubricating properties to facilitate smooth assembly of heavy interference or high torque fits. Prevents galling and metal pick-up during assembly.

Loctite® 660



Used for repairing worn coaxial parts without re-machining. Enables reuse of worn bearing seats, keys, splines, tapers, or for retaining shims.

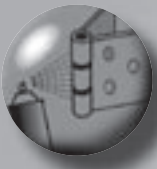

Anti-Seize Lubricants



Loctite® brand Anti-Seize compounds are a range of premium quality products, developed to protect metal parts from corrosion, galling and seizing. They ease assembly and disassembly of slip fit and threaded joints, and reduce friction and wear. Formulated for severe environments, these products protect against high temperatures up to 1315°C, in conjunction with heavy loads and chemical corrosion.

Features & Benefits

High Temperature Resistance – Formulated with high quality grease and solid lubricating agents for optimal temperature resistance up to 1315°C.

Reduces Friction & Wear – Reduces metal-to-metal contact resulting in less friction and wear.

Seals Against Corrosion – Displaces and seals against contact with moisture and other corrosive liquids.

Metal Free Available – For use in environments that prohibit use of copper or where dissimilar metals are used.

Convenient Packaging & Easy Use – Available in tubs, tubes, aerosols and the patented stick applicator. Tubs include a brush attached to the lid for no-mess application.

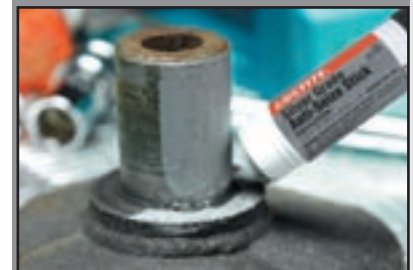

Did You Know?

Effective Anti-Seize lubricants increase assembly strength!

An anti-seize lubricant used on a bolt helps to develop greater clamp load for the same torque compared to an unlubricated bolt. However care should be taken to avoid over-stressing a bolt caused by excessive lubrication. Loctite® anti-seize products provide a controlled torque coefficient which ensures consistent clamp load when tightening.

Anti-Seize lubricants act as an 'Internal Galvaniser'!

The use of an anti-seize product is an excellent method of preventing galvanic corrosion, especially in hot, acidic, or caustic environments. Anti-seizes resist galvanic attack by sacrificing the metals in the anti-seize in preference to the metal parts under protection.

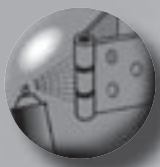

Anti-Seize Lubricants

Product Selector

1 What type of Anti-Seize do you require?

2 Maximum Temperature

3 Unique Features

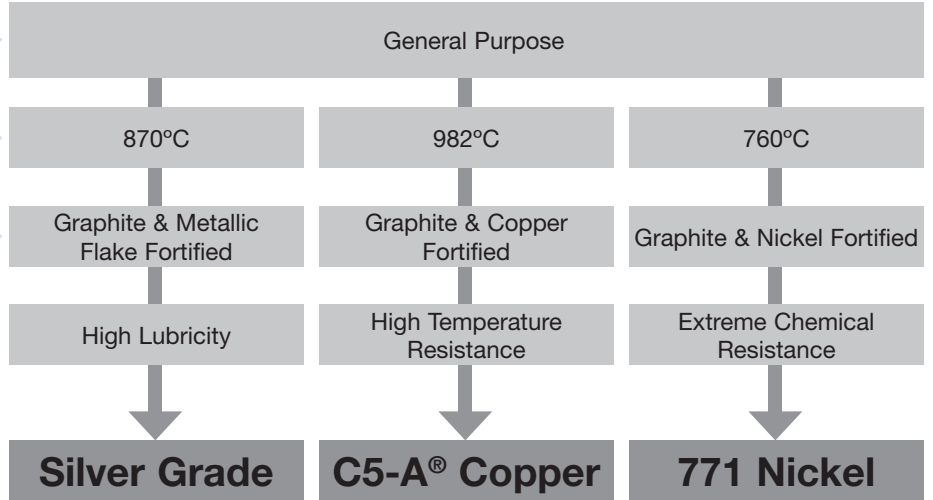

Solution

	Silver Grade	C5-A [®] Copper	771 Nickel
Colour	Silver	Copper	Silver
Solid Lubricating Agent	Aluminium/Graphite	Copper/Graphite	Nickel/Graphite
Torque Coefficient (<i>K value</i>)	0.18	0.16	0.13
Temperature Range	-29°C to +870°C	-29°C to +982°C	-29°C to +760°C
Metal Free	No	No	No
Size (Part Number)	20gm stick (37783B) 200gm aerosol (76756) 236ml brushtop (76732) 250gm tube (76741) 500gm brushtop (76769) 5kg bucket (76731) 10kg bucket (76785) 194kg drum (76779)	340gm aerosol (51003) 453gm brushtop (51007)	28gm tube (28182A) 500gm brushtop (39163)

K value on steel nuts and bolts. For further information refer to product Technical Data Sheet.

Product Description



Loctite[®] Silver Grade Anti-Seize



Heavy Duty, temperature resistant, petroleum based lubricant compound fortified with graphite and metal flake. Inert, will not evaporate or harden in extreme cold or heat. For use in assemblies up to 870°C.

Recommended for:

- General purpose machine and bolt assembly.
- Close tolerance assembly
- Fine threads and snug slip fits.

Loctite[®] C5-A Copper Anti-Seize



Exclusive formula suspends copper and graphite in a high quality grease. Protects metal parts from rust, corrosion, galling and seizing at temperatures to 982°C.

Recommended for:

- Nuts, bolts and studs.
- Fittings and shafts, machine surfaces.
- Fittings on steam turbines, pumps and valves.
- Flanges, extruders and dies.

Loctite[®] 771 Nickel Anti-Seize



Copper Free formulation with extreme chemical resistance, recommended for stainless steel and other metal fittings. Prevents corrosion, seizing and galling in harsh chemical environments at temperatures to 760°C.

Recommended for:

- Chemical plants and oil refineries.
- Water and sewage plants.
- Environments where a 'clean' inert lubricant is needed.

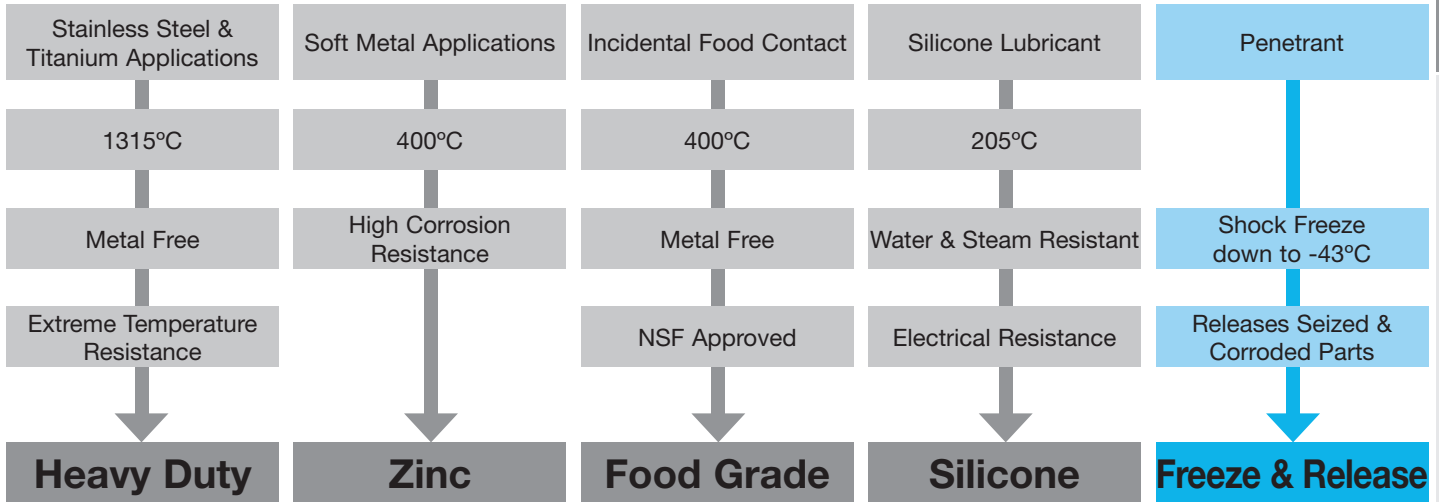

Black	Grey	White	Translucent Paste	Clear Liquid
Calcium/Graphite	Zinc	Calcium	Silicone	-
0.16	0.15	0.13	-	-
-29°C to +1315°C	-29°C to +400°C	-29°C to +400°C	-29°C to +205°C	-
Yes	No	Yes	Yes	Yes
510gm brushtop (51606)	454gm tin (39901)	226gm brushtop (51168)	150gm tube (51360)	310gm aerosol (FAR)

Loctite® Heavy Duty Anti-Seize

Metal Free



Metal free formulation provides outstanding lubrication to all metals including stainless steel, aluminum and soft metals up to 1315°C.

Recommended for:

- OEM specified turbine studs and bolts.
- Ethylene and acetylene piping.
- Petrochemical plants.
- Environments prohibiting the use of copper.

Loctite® Zinc Anti-Seize



Smooth mixture of zinc dust and petrolatum grease that acts like an 'internal galvaniser' for superior protection of aluminum and ferrous surfaces from seizure and corrosion up to 400°C.

Recommended for:

- Protecting aluminum, aluminum alloy, and ferrous metal from seizing and corrosion.

Loctite® Food Grade Anti-Seize

Metal Free



Metal free formulation provides high levels of purity and excellent lubricating properties for use on equipments with incidental food contact at temperatures up to 400°C.

Recommended for:

- Lubricating and protecting parts in food processing plants, breweries, packaging plants and hospitals.

Loctite® Silicone Lubricant



Non-curing silicone paste that seals, lubricates, protects, waterproofs, and electrically insulates metal, rubber, and plastic parts. Will not tarnish paint, rubber or plastic surfaces.

Recommended for:

- Plug or ball valve, valve stem packing and protecting electrical contacts.
- Stopping leaks.

Loctite® Freeze & Release

NEW



Shock-freezes seized and rusted parts down to -43°C, causing microscopic cracks in the rust and allowing the lubricant to penetrate. The assembly can be easily dismantled after allowing 1-2 minutes and parts remain lubricated and protected from corrosion.

Recommended for:

- Seized and or rusted components.

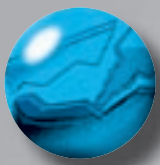

Bonding

Features & Benefits

- ✓ Convenient repairs in seconds
- ✓ High shear and peel strength
- ✓ No mixing
- ✓ Bonds to a wide variety of materials
- ✓ Extensive range available, suitable for infinite industrial maintenance and OEM applications.



Product Selector

1 What are you bonding?

2 Do you require instant adhesion?

3 Is the surface porous?

4 Unique Features

Porous

Instant Fixture

Easy Application

Control Gel

Solution

Colour	Clear
Gap Fill	0.10mm
Viscosity	Gel
Shear Strength# N/mm ² (PSI)	20 (2,930)
Temperature Range	-54°C to +82°C
Fixture Time	5–20 sec
Full Strength	24 hrs
Recommended Activator/Primer	-
Size (Part Number)	3gm dispenser (40778)

Grit blasted steel cured for 24 hours at 22°C. * Applied @ 22°C / 50% relative humidity.

Product Description

Henkel Corporation, the manufacturer of Loctite® products, is the world leader of structural and instant adhesive bonding solutions. Our advanced adhesives range includes Cyanoacrylates, Epoxies, Hot Melts, Light Cure, Silicones, Urethanes and Acrylics for maintenance and OEM applications.

The Loctite® adhesive products shown here is a targeted selection of maintenance bonding solutions. Call the Loctite® Customer Support Line for more information on our full product range.

Loctite® Control Gel



The ultimate adhesion tool, this multi-purpose instant adhesive features a self-piercing precision applicator. The spill-proof robust design offers improved control and accuracy. Also available in lower viscosity – Loctite Control Liquid (40779).

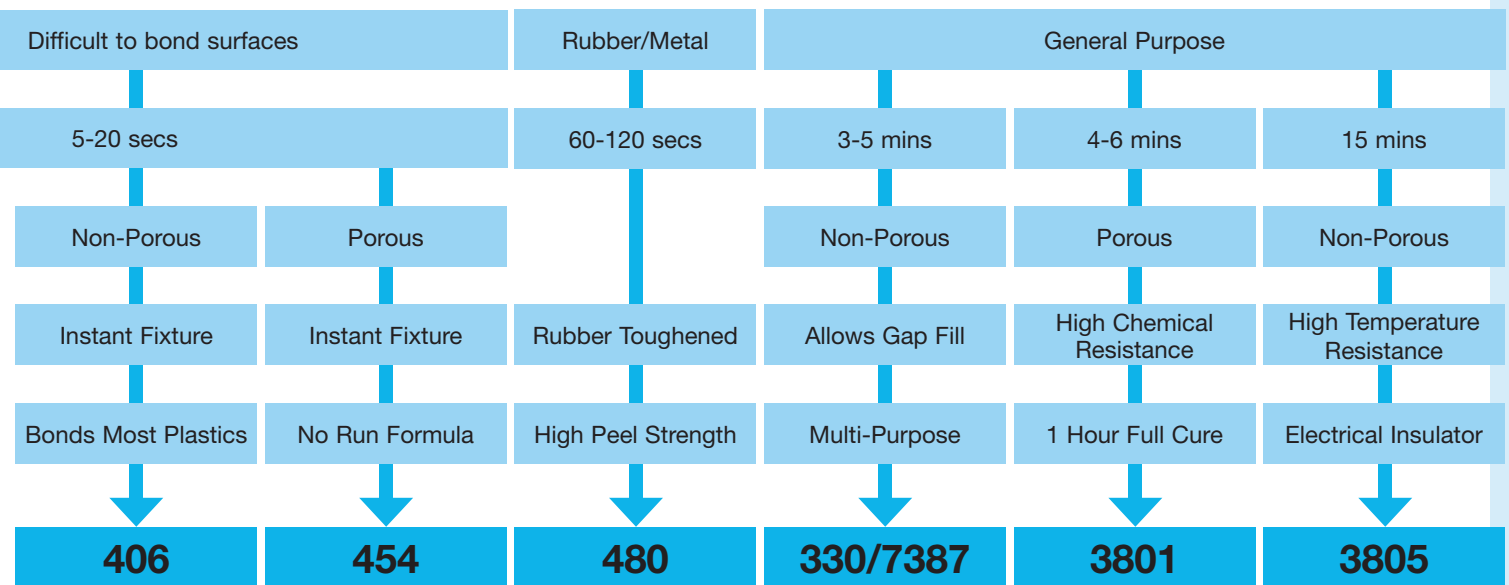

Clear	Clear	Black	Amber	Amber	Grey
0.10mm	0.10mm	0.10mm	0.50mm	0.20mm	0.20mm
20 CP	Gel	200 CP	Gel	Gel	Heavy Paste
22 (3,200)	22 (3,200)	26 (3,800)	23 (3,300)	16 (2,300)	6.9 (3,000)
-54°C to +82°C	-54°C to +82°C	-54°C to +100°C	-54°C to +120°C	-54°C to +82°C	-54°C to +150°C
5-20 sec	5-20 sec	60-120 sec	3-5 min	4-6 min	10-15 min
24 hrs	24 hrs	24 hrs	24 hrs	1 hr	16 hrs
770	-	770	7387	-	-
25ml bottle (40633-25) 100ml bottle (33533) 500ml bottle (33534)	3gm tube (45404) 20gm tube (45416A) 200gm tube (45474)	25ml bottle (16819-25) 500gm bottle (16887)	50ml kit (20251) 300ml cartridge (33064)	25ml dual syringe (20981)	56gm kit (24180)

For further information refer to product Technical Data Sheet.

Loctite® 406



General purpose adhesive for difficult to bond surfaces. Bonds Santoprene® rubbers, polyolefin plastics and elastomers when used in conjunction with Loctite® 770 Polyolefin Primer. Also available in higher viscosity grade, Loctite® 401 25ml (40124-25) 100ml (33531) and 500ml (33532).

Loctite® 454



General purpose gel for bonding metals, composite materials, wood, cork, foam, leather, card, paper, plaster and unglazed ceramics. Recommended for use on vertical or overhead surfaces. Fills gaps to 0.5mm with the use of Primer 7452.

Loctite® 480



Black rubber toughened grade for bonding metal to metal and metal to rubber; especially suitable with applications where high peel strength is required and/or shock loads are present.

Loctite® 330 Multi-Bond Kit



This multi-purpose adhesive suits most bonding needs including metal bonding, ID plates and signage. Two part, no mix, fast curing and toughened with good moisture, impact resistance and peel strength. (50ml kit includes 7387 Activator 25gm).

Loctite® 3801



Conventional dual syringe, two-part epoxy. Ideal for emergency repairs or where fast cure time is required. Sets in 5 minutes. Resistant to a wide range of chemicals and solvents, and acts as an excellent electrical insulator.

Loctite® 3805



Fast setting, two component adhesive and filler system, ideal for repairs, filling, bonding to iron steel brass, bronze, aluminum and copper. Can be drilled, tapped, threaded or filed and is an excellent electrical insulator. Typically used under speedy sleeves.



Primers & Activators

Features & Benefits

- ✓ Activates inactive surfaces and speeds cure time
- ✓ Speeds cure through larger gaps and deep threads

Active Surfaces (Primer optional)	Brass, copper, bronze, iron, soft steel
Inactive Surface (Primer required)	Aluminium, stainless steel, magnesium, zinc, black oxide, cadmium, titanium, nickel, others



Product Selector

1 Do you need an activator or primer?

2 What type of product are you using?

3 Which product are you using?

Anaerobic
Thread Sealing,

232, 248, 262, 277,
290, 515, 518, 561,
567, 620, 641,
668

Solution

7649

Description	Activator
Base Solvent	Acetone
Drying Time at 20°C	30 to 70 secs
On-Part Life	30 days
Size (Part Number)	100ml pump (22410A) 3.78ltr can (24063A)

Product Description

Loctite® 7649



Use to increase the cure speed of Loctite® brand anaerobic products, especially at low temperatures, in applications with passive metals or inert surfaces, or where large gaps are involved.

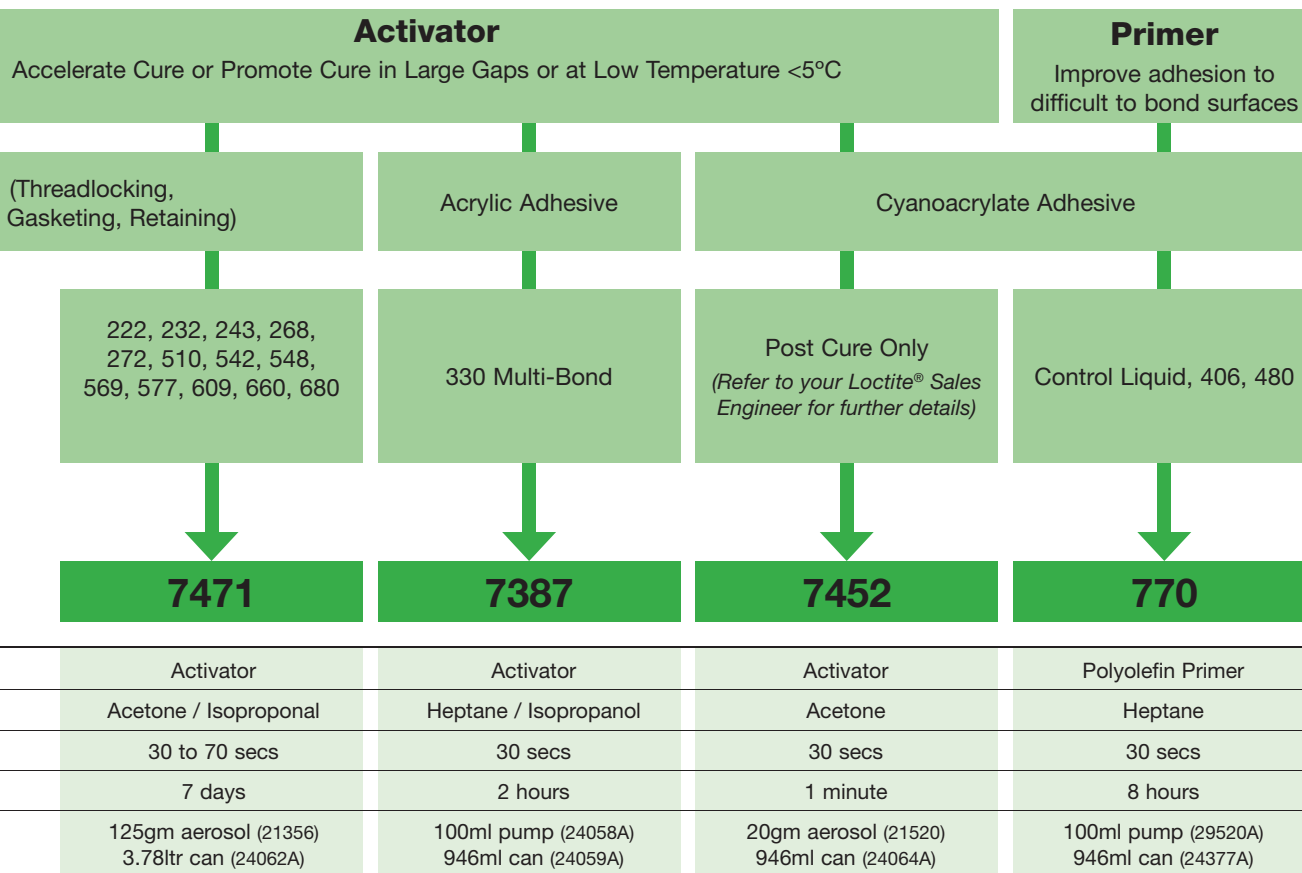

Loctite® 7471



Use to increase the cure speed of Loctite® brand anaerobic products, especially at low temperatures, in applications with passive metals or inert surfaces, or where large gaps are involved.

Loctite® 7387



Required to initiate the cure of Loctite® brand toughened acrylic adhesives.

Loctite® 7452



Applied after adhesive to speed cure of Loctite® brand cyanoacrylate adhesives. Typical applications include securing wires to coils or PCB's and tamper-proofing adjustments and mounting edge guides or stiffeners.

Loctite® 770



Helps to provide strong reliable bonds with Loctite® brand cyanoacrylates on "impossible" substrates like polypropylene, polyethylene, PTFE and thermoplastic rubber.



Rust Treatment & Cleaning

Features & Benefits

- ✓ Effective rust converter formula for surface preparation of all metals
- ✓ Fast acting and non-corrosive gasket remover eliminates need for scraping and sanding
- ✓ Fast and effective industrial grade cleaners
- ✓ Premium-grade hand cleaner with skin conditioners to soothe and protect hands

Product Selector

1 What is your task?

Rust Treatment

2 What are you cleaning?

3 Unique Features

Converts Rust

Protects Surface

754

Solution

Appearance	Milky Liquid
Temperature Range	Up to 121°C
Dry Time	30 min
KB Values [#]	-
Size (Part Number)	946ml bottle (75430) 3.78ltr bottle (75448) 18.9ltr bottle (75465)

[#] Kauri-Butanol Values tested to ASTM D 1133. (Determines relative solvent power of hydrocarbons)

Product Description

Loctite® 754
Extend® Rust Treatment



Converts existing rust into a stable base. Cured product acts as a primer ready for painting. Protects surfaces from corrosion. Use on metal pipes, valves, fittings, storage tanks, fences, guard rails, conveyors, construction and agricultural equipment.



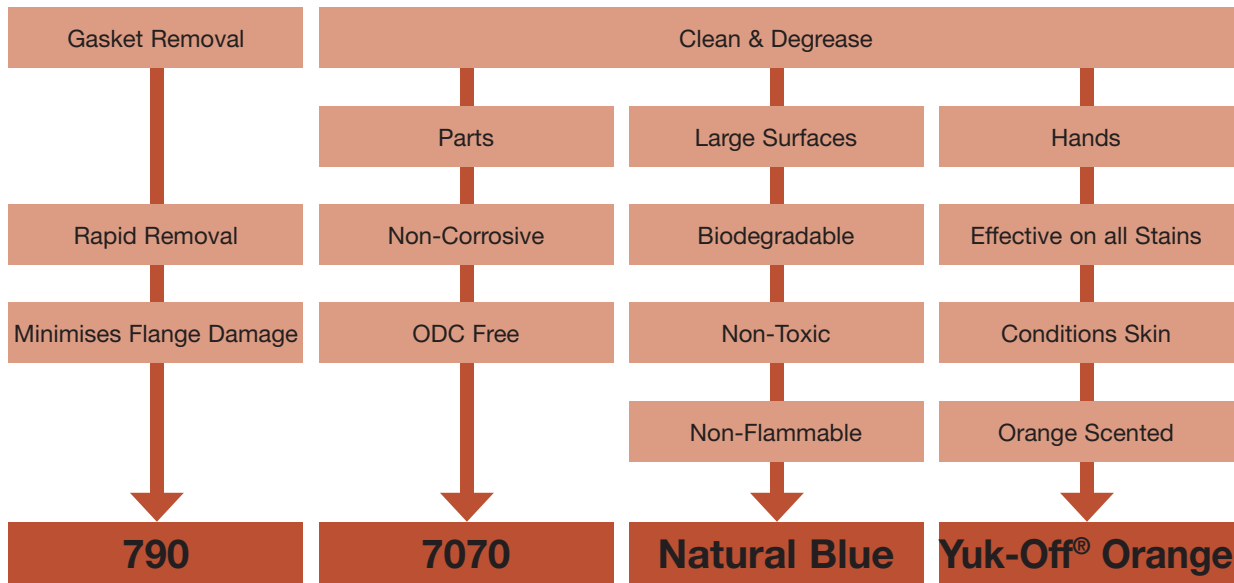

White Liquid	Clear Liquid	Blue Liquid	White Lotion
-	-	-	-
-	5 – 20 min	-	-
>200	31	-	-
510gm aerosol (79040)	473ml aerosol (20162)	709ml bottle (82249) 3.78ltr bottle (82251) 18.9ltr bucket (82253)	400ml bottle (31908) 4ltr pump (31909) 15ltr bucket (31910)

(hydrocarbon solvents). Dry time is dependant on temperature. For further information refer to product Technical Data Sheet.

Loctite® 790
Chisel® Gasket Remover



Removes gaskets from any type of assembly in 10 to 15 minutes. Prepares metal parts for new gaskets, eliminating scraping and sanding. Suitable for wood and is non-corrosive to aluminium. Not for use with plastics, linoleum or synthetic fibres.

Loctite® 7070
ODC Free Cleaner & Degreaser



General purpose parts cleaner and degreaser which contains no ozone depleting chemicals. Prepares surface for bonding and is non-corrosive and plastic compatible. Removes grease, oil and dirt from electrical parts, tools, bearings, controls, and precision equipment.

Loctite® Natural Blue®
Cleaner & Degreaser



A biodegradable, all-purpose, industrial strength, concentrated cleaner and degreaser, Natural Blue® contains no hazardous solvents. Formulated for wipe down, pressure spraying and immersion cleaning processes, Natural Blue® can be economically diluted with water at room temperature or heated, to meet a wide range of industrial cleaning applications. ODC free, non flammable, non-toxic and pine scented. (709ml is diluted 1:1 ready for use).

Loctite® Yuk-Off®
Orange Hand Cleaner



Contains premium-grade cleansing agents that quickly dissolve dirt, grease, resin, ink, paint, glue, tile cements and other stubborn stains. Citrus-based, smooth formula is PH balanced and fortified with skin conditioners lanolin, aloe vera, Vitamin E, jojoba and wheat germ extract to soothe and protect raw, rough hands. *Wall bracket dispenser available for 4ltr bottle (p/n: 90128).*



Kit & Emergency Repairs

Features & Benefits

Tool Kits

- ✓ Contains essential tools for industrial maintenance and repair

Emergency Repair Products

- ✓ Easy to use – does not require specialised equipment
- ✓ Enable rapid repair of damaged equipment



Product Selector

1 Industrial Maintenance Kits

20 x Products

2 Emergency Repair Kits

3 Features & Benefits

Comprehensive

Free Tool Box

Solution

Top Line Kit

Contents

Threadlockers - 243, 262, 271, 290 50ml
 Retaining Compounds - 609, 641, 660, 680 50ml
 Thread Sealants - 515, 567, 569 50ml
 Bonding Adhesives - 406 25ml, 454 20gm, 3805 56gm
 Anti-Seize Lubricants - Silver Grade, 771 Nickel 500gm
 Primers - 7471 125gm, 7649 100ml
 Others - 790 Chisel® Gasket Remover 510gm, Form-A-Thread 13.1ml

Size (Part Number)

Kit (00192)

Product Description

Loctite® Top Line Kit



Contain all the essential tools for industrial maintenance reliability including Threadlocking, Retaining Compounds, Thread Sealing, Bonding Adhesives, Anti-Seize Lubricants and Primers.

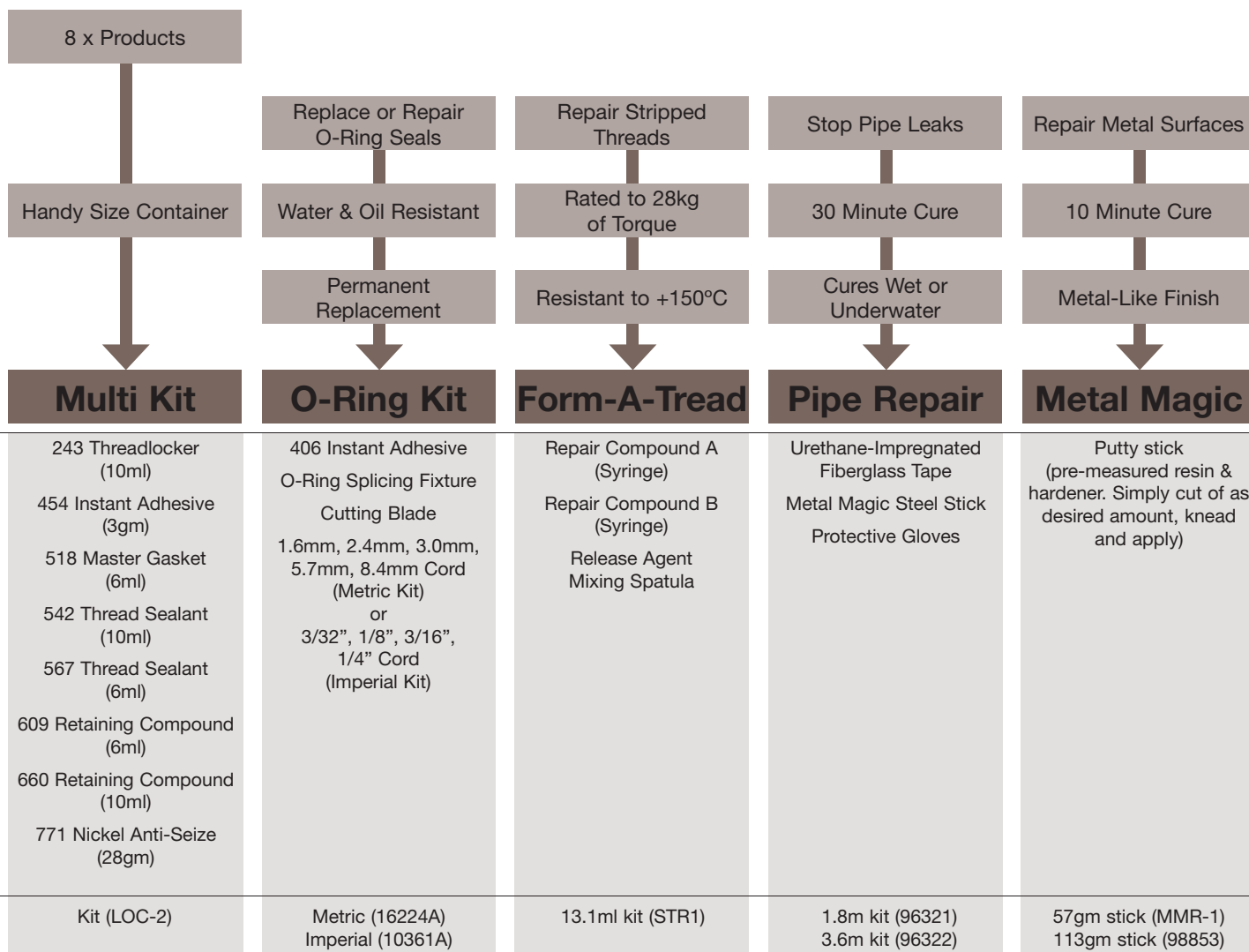

Loctite® Multi Kit



Handy sized kit designed to fit into a tool chest. Includes a Threadlocker, Instant Adhesive, Thread Sealants, Retaining Compounds and Anti-Seize Lubricant.

Loctite® O-Ring Kit



Contains all of the materials necessary to produce stationary o-rings on the spot. Saves time by allowing o-ring replacement without disassembling machinery. Eliminates the need for inventory of different sized o-rings.

Loctite® Form-A-Thread



Permanently repair stripped threads and fasteners in five minutes without machining. Suitable for all size threads in a wide variety of metal and wood. Handling strength cure in 5 minutes and full cure in 2 hours. Resistant to most shop fluids.

Loctite® Pipe Repair Kit



Recommended for reliable, temporary repairs of metal, plastic and composite pipes. Easy to use - no tools are required and can be applied to odd shapes as required. Cures in 30 minutes and can be sanded or painted.

Loctite® Metal Magic



Easy to use, steel-filled compound designed for emergency maintenance repairs on damp, dry or underwater surfaces. Cures to a metal-like finish in less than 10 minutes under typical temperatures of -30°C to +121°C

LOCTITE®

THE MASTER OF KNOWLEDGE

Information is one of the cornerstones of maintenance and repair. Knowledge that determines selection of the correct product, confidence that drives professional application and satisfaction that comes from a successful repair are the products of carefully designed and presented training programs.

One of the reasons that Loctite has become the world's leading brand of adhesives and sealants is the constant flow of knowledge provided to users. For over 50 years, thousands of Loctite users have been provided with the training that delivers professional results in equipment maintenance and repair. Training programs are available for:

THREADLOCKING
RETAINING
THREAD SEALING
BONDING
GASKETING
LUBRICATION

Call today to schedule a training session at your plant. Learn the methods, practice the techniques and experience the results. You can continue to be the Master of Knowledge.

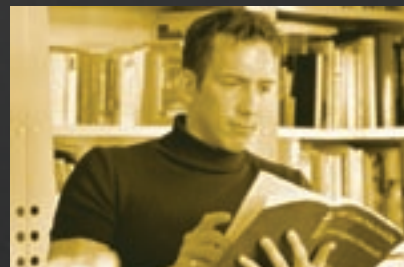



Technical References

Ten Points About Liquid Threadlockers

By Rick Skibba
Henkel Corporation, Rocky Hill, CT

Bolts, studs, set screws and other threaded fasteners are the “ties that bond” industrial equipment together. Considering that fastener loosening is a leading cause of catastrophic failure in machinery, maintaining proper clamping forces is an important element in fastening effectiveness.

Liquid anaerobic threadlockers are an excellent method of keeping fasteners firmly in place. Listed here are ten points that plant personnel should know about using liquid anaerobic threadlockers:

It's not just a bolt. The real function of nuts and bolts is to provide clamping force to hold two components together. If that clamping force decreases, the fastener begins to slip, and failure become inevitable.

Thread space is the enemy. There can be as little as 15% metal-to-metal contact between the thread of a nut and bolt. The empty space leaves room for movement that leads to self-loosening and loss of clamping force.

Side movement causes failure. Fasteners work loose for complex reasons, but a key cause is sideways movement. Bolted surfaces can slide sideways as a result of thermal expansion, bending of the assembly, impact or vibration. As this happens, the bolt takes on a rocking motion that causes the threads to wear against each other. In time, the bolt becomes almost frictionless, and the threads can unwind.

Threadlockers stop all kinds of movement. Liquid anaerobic threadlockers attack the root cause of loosening by filling spaces between the threads. The result is a secure, one-piece assembly that will not loosen under stress.

Sealing stops corrosion. By sealing between thread spaces, threadlockers keep out air and moisture that can cause corrosion – another common cause of

fastener failure. Because of their chemical resistance, threadlockers seal effectively in contact with most fluids, gases, and solvents used in industry. (Refer to *Fluid Compatibility Chart* - pg 42 & 43).

Threadlockers hold better. In test on transverse shock and vibration machines, liquid threadlockers drastically outperformed mechanical devices (see graph). Bolts secured with threadlocker retained nearly all their clamping force after more than 1,000 cycles.

Mechanical devices began to fail almost immediately.

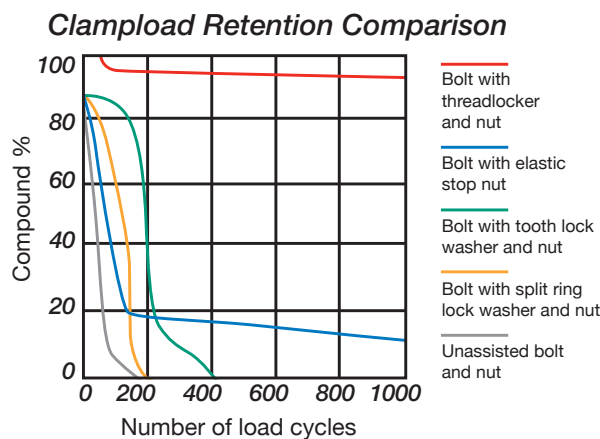

In test on transverse shock and vibration machines, liquid threadlockers drastically outperformed mechanical locking devices

Better performance cost less. Mechanical locking methods are effective to some degree, but are difficult to justify based on cost. A special nut or washer can cost more than four times as much as an application of liquid threadlocker. Mechanical devices also require extensive and costly inventories to keep the range of sizes on hand. Three or four grades of threadlocker – easy to carry and colour-coded, serve the same purpose.

It will come out. All threadlocked fasteners can be disassembled. Different grades of threadlockers can be used depending on the job. Fasteners secured with low and medium strength grades can be removed with common hand tools. Those secured with high strength grades can be removed by applying heat for a specified time. (Refer to *High Strength Disassembly guide* - pg 38)

Threadlockers ease assembly and disassembly. When wet, threadlockers lubricate fasteners, allowing proper, consistent assembly tightening and torque. When cured in place, threadlockers stop corrosion, thus preventing seizure and allowing for ease in disassembly.

There is no “downside”. Liquid threadlockers are not just for certain specialized uses. They perform effectively on fasteners and threaded assemblies of any type and size, in any kind of equipment.



Technical References

Loctite® at Work

Loctite® Threadlocker Saves +\$73,000 per Year

Situation:

A large wood and lumber manufacturer was experiencing mechanical failure and unscheduled downtime due to fastener loosening on their limit switch arms. Limit switches translate motion into switch actuation. The maintenance department found the screws were loosening in the arms, which allowed the wand to fall out or become misaligned. A maintenance person was assigned to tighten all the screws. This task took about 5 to 10 minutes to complete and occurred at least twice per shift. Each time the task is completed, the equipment must be “tagged out,” tightened and brought back on line. In one year, it was found that over 91 hours had been spent on labor and downtime.

Solution:

Based on the advice of a Loctite® Application Engineer, the maintenance personnel of this manufacturer chose Loctite® 222 Threadlocker to remedy their limit switch situation. Loctite® 222 is applied before the fasteners are assembled and is recommended for small fasteners less than 6mm (1/4”). Once cured, Loctite® 222 has a torque removal resistance of up to 14Nm and can be easily disassembled with standard hand tools. It resists vibration loosening and does not breakdown when in contact with various shop chemicals.

Results:

Loctite® 222 Threadlocker unitised the screws within the assembly and prevented them from vibrating loose. Since implementing this technique, the manufacturer has saved over \$73,000 of labor and downtime in just one year.



Maintaining Mine Production with Loctite® Retaining Compound

Situation:

Mine production depends on how quickly material can be reclaimed and transported to the milling operation. Any downtime may result in significant lost production, therefore effective equipment maintenance is vital.

A bucket loader at a large open mine site suffered from regular failure caused by the extreme shock and impact on the hinge arms and pin bearings. A shrink fit was used to insert the hinge pin bearings into the hinge arm, but surface imperfections on the bushing created space which allowed for movement and corrosion.

Every time the hinge pin bearings pounded out the housing, maintenance on the equipment was required. Mine engineers needed to find a better way to secure the hinge pin bearings into the hinge arm that would increase in-service time for the bucket loader and so consulted their Loctite® Application Engineer.

Solution:

The worn hinges were machined to round and sized 0.1mm smaller than the sleeve overall diameter. All surfaces were cleaned with Loctite® 7070 ODC Free Cleaner. After cooling the replacement sleeve, Loctite® 680 was applied to the housing and the sleeve. The sleeve was slid into place and allowed to cure for 24 hours.

Loctite® 680 Retaining Compound is a medium-viscosity, fast curing retaining compound. It fixtures in 10 minutes at room temperature and provides a shear strength of 19.3N/mm² on steel.

Results:

Augmenting the shrink fit with Loctite® 680 completely filled any voids in the fit of the two parts. This added a significant amount of strength to the final assembly and sealed against corrosion, enabling the bucket loader to stay in service longer.



Loctite® at Work

Pro-Active Maintenance Stops Leaks Before They Happen

Problem:

A large university employs 40 steamfitters to maintain its central heating and cooling system in over 300 buildings. In one situation, the maintenance team was replacing 76mm (3") diameter chilled water piping using a different style of piping. The threads had to be re-cut to make the fit and Teflon® tape was used to seal the joined piping. Later, callbacks were necessary due to leakage. The callbacks were costing more than the original repair because maintenance personnel had to tear everything apart and start the repair over again. At \$55 an hour, the cost was adding up rapidly.

Solution:

Joe Baldwin, Craftworker Supervisor, had recently attended Loctite Maintenance Training where he learnt about 567 PST Pipe Sealant with Teflon.

Loctite® 567 PST, used in conjunction with Loctite® Primer N, seals stainless steel, galvanized and other inert metal fittings. It's excellent for high pressure applications up to 69MPa on fittings ranging from 12mm (1/2") to 76mm (3") diameter and withstands continuous temperatures from -53°C to +204°C.

Results:

After applying 567 PST to the pipe threads, no leaks occurred, and no callbacks were necessary.

Now Joe and his team use 567 PST proactively. "PST Pipe Sealant may cost a little more (as compared to traditional methods of pipe sealing such as Teflon tape and hemp) but it more than pays for itself because we use it only once and never get a callback," said Joe. "Now whenever we absolutely, positively don't want any leaks, we use and trust 567 PST."



Saving Time & Money with Loctite® Anaerobic Gaskets

Problem:

With over 100 gear boxes on this steel company's roll line, maintenance is a costly expense. Replacement of shear pins is frequent, making disassembly a regular maintenance chore. The high vibration and heavy shock loads experienced by the gear boxes loosen the bolts which mount the housing. Cut gaskets were used to seal the end bells, but leaks were a real problem.

Solution:

Better able to withstand vibration, liquid gaskets provide a more precise and reliable seal than cut gaskets. Loctite® 515 Gasket Eliminator is now applied to both front and rear bell housings of the gear boxes, replacing cut gaskets. Loctite® 515 Gasket Eliminator® is a general purpose anaerobic sealant primarily used for making flexible gaskets.

Results:

Using Loctite® 515 Gasket Eliminator instead of cut gaskets provided many cost-cutting improvements for our customer:

1. No need to carry stock of pre-cut gaskets. Loctite® Formed-in-Place Gaskets can be made to any size or shape.
2. Downtime was significantly reduced due to fast repair time. Loctite® 515 is easy to apply and cures to a low pressure seal within 30 minutes
3. Costly oil leakage and clean-up eliminated, saving critical downtime and money.



Loctite® Formed-in-Place Gaskets eliminate the expense of carrying countless inventory of pre-cut gaskets





Technical References

Application Procedures

THREADLOCKING

THROUGH HOLE (BOLTS AND NUTS)

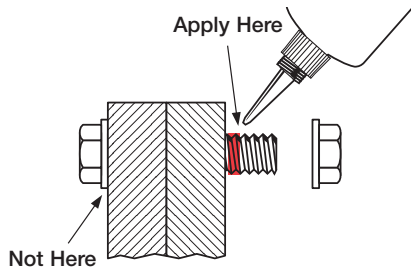

1. Clean all threads (bolt and nut) with Loctite® ODC-Free Cleaner & Degreaser.
2. If necessary, spray all threads with Loctite® Primer (Refer to Technical Data). Allow to dry.
3. Select the proper strength Loctite® Threadlocker product.
4. Insert bolt into through hole assembly.
5. Apply several drops of Threadlocker onto bolt at targeted tightened nut engagement area. Avoid touching bottle tip to metal.
6. Assemble and tighten nut as usual.

BLIND HOLES (CAP SCREWS, ETC.)

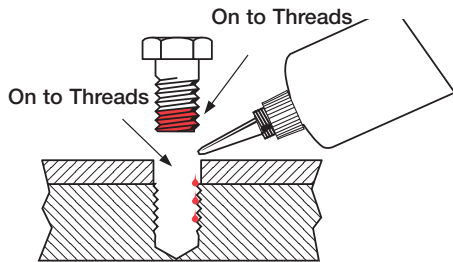

1. Clean all threads (bolt and hole) with Loctite® ODC-Free Cleaner & Degreaser.
2. If necessary, spray (bolt and hole) with Primer (Refer to Technical Data). Allow to dry.
3. Select the proper strength Threadlocking product.
4. Squirt several drops down the sides of the female threads.
5. Apply several drops to bolt. Avoid touching bottle tip to metal.
6. Tighten as usual.

Note: Using Loctite® Threadlockers will virtually eliminate stripped threads in aluminium or magnesium housings caused by galvanic corrosion.

PRE-ASSEMBLED FASTENERS

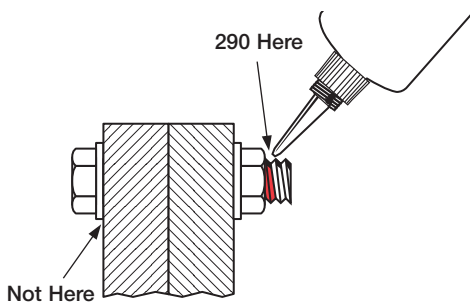

1. Clean bolts and nuts with Loctite® ODC-Free Cleaner & Degreaser.
2. Assemble components.
3. Tighten nuts.
4. Apply drops of Loctite® 290 Threadlocker at the nut and bolt juncture.
5. Avoid touching bottle tip to metal.

Note: For preventive maintenance on existing equipment: RETIGHTEN nuts and apply Loctite® 290 Threadlocker at the nut and bolt juncture.

HIGH STRENGTH DISASSEMBLY

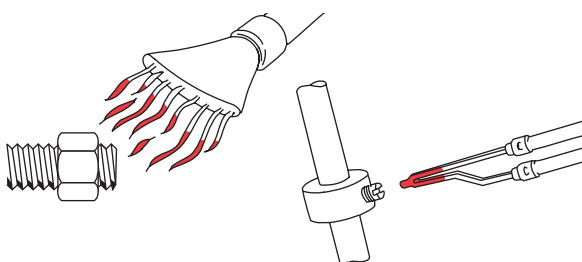

Localised Heating Methods

1. Apply localized heat to nut or stud (230°C for 5 minutes).
2. Disassemble while HOT.

Note: Use standard hand tools for disassembly of low and medium strength Threadlockers.

Application Procedures

THREAD SEALING

STANDARD FITTINGS — PIPE, HYDRAULICS, POTABLE WATER OR AIR

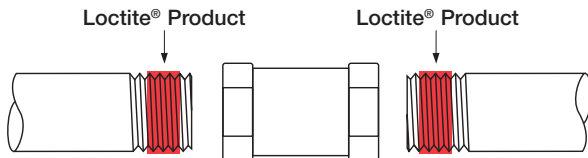

1. Clean parts of contamination with ODC-Free Cleaner & Degreaser. If necessary, spray Loctite® Primer (Refer to Technical Data) onto threaded parts (male and female). Allow to dry.
Note: Primer is not required for brass parts.
2. Apply a band of Loctite Product to male threads starting one to two threads from end of pipe.
3. Assemble parts snugly. Do not overtighten.
4. If initial pressure exceeds 6.9 MPa*, wait 30 minutes before pressurizing.

Note:

- If sealing chemicals or strong acids/bases, refer to Fluid Compatibility Chart (pg 42-43).
- Do not use on oxygen or strong oxidisers (chlorine).
- Refer to Loctite® Thread Sealing selector Chart (pg 12-13) for correct product selection

*Depending on conditions

METAL PIPE UNIONS

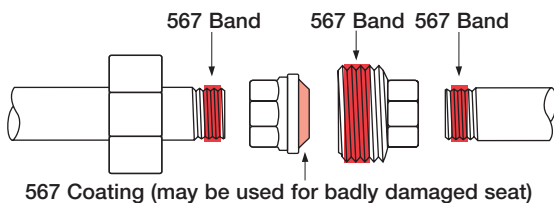

567 Coating (may be used for badly damaged seat)

1. Disassemble and if necessary, spray all components with Loctite® **7649** Primer. Allow to dry.
2. Apply a thin coating of **567** PST® Pipe Sealant to union face.
3. Apply a band of **567** PST® Pipe Sealant to male threads.
4. Assemble parts snugly.

SHAFT MOUNTED COMPONENTS

SLIP FIT — LIGHT DUTY

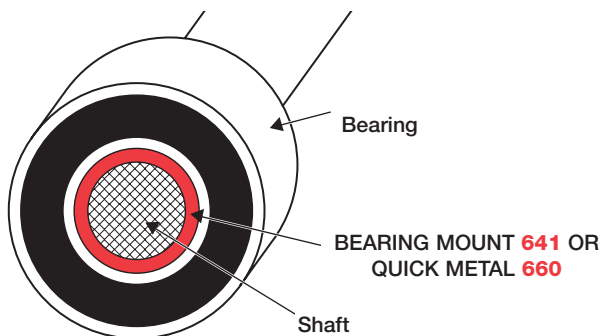

ORIGINAL

1. Clean all parts with Loctite® ODC-Free Cleaner & Degreaser.
2. Spray all parts (I.D. and O.D.) with Loctite® Primer (Refer Technical Data).
3. Apply Loctite® **641** dabs around shaft at engagement area.
4. Assemble parts as normal.
5. Wipe off excess.
6. Allow 20 minutes cure time prior to service.

WORN SHAFT

Follow directions above except:

1. Determine radial gap.
2. If radial gap exceeds 0.1mm, Loctite® Primer must be used.
3. Take steps to maintain concentricity with large gaps.
4. Larger gaps require longer cure times (30-60 minutes).
5. Loctite® QUICK METAL® **660** is NOT recommended for radial gaps exceeding 0.5mm.

Note: Loctite® QUICK METAL® **660** is very fast fixturing (30 seconds or less) with Loctite® **7471** Primer (T).



Technical References

Application Procedures

FORMED-IN-PLACE GASKETING

SEALING CAST RIGID FLANGES

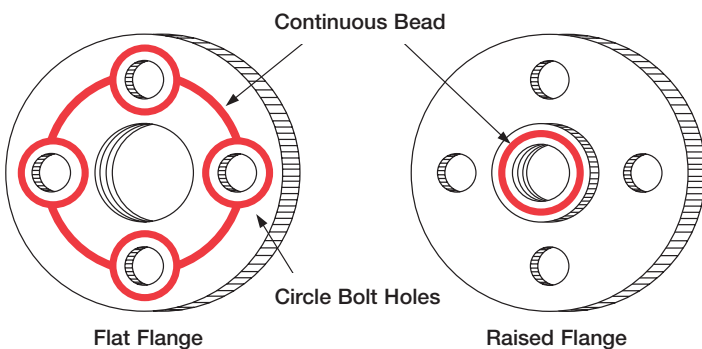

1. Remove old gasketing material and other heavy contaminants with Loctite® CHISEL® Gasket Remover. Use mechanical removal technique if required.
Note: Avoid grinding.
2. Clean both flanges with Loctite® ODC-Free Cleaner & Degreaser.
3. Spray Loctite® Primer (Refer Technical Data) on only one surface. Allow to dry.
4. Apply a continuous bead of SELECTED LOCTITE® GASKETING PRODUCT to the other surface.
Note: Circle all bolt holes with sealant, if appropriate.
5. Mate Parts. Assemble and tighten as required. **Note:** Immediate assembly not required; however avoid delays over 45 minutes (assemble immediately if primer is used).
6. Allow to cure:
 - a. No pressure – immediate service
 - b. Low pressure (up to 3.45MPa) – 30 to 45 minutes
 - c. High pressure (3.45 to 17.2MPa) – 4 hours
 - d. Extreme high pressure (17.2 to 34.45MPa) – 24 hours

STAMPED OR SHEET METAL FLANGES

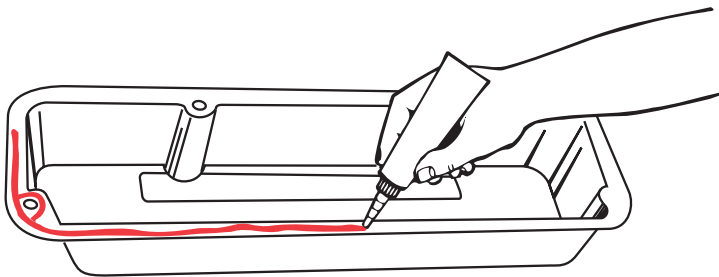

1. Remove old gasketing material and other heavy contaminants with Loctite® CHISEL® Gasket Remover.
2. Clean both flanges with Loctite® ODC-Free Cleaner & Degreaser.
3. Apply a continuous bead of the selected Loctite® MAXX® SILICONE to sealing surface. Circle all bolt holes.
Note:
 - Use proper bead diameter to seal flange width and depth.
 - Minimize excessive material “squeeze in”.
4. Assemble within 10 minutes by pressing together. Tighten as required.
5. Clean up any excess.
6. Cure times will vary with temperature, humidity, and gap.

Refer to Loctite® Do It Right Users Guide for further application procedures such as;

Threadlocking

- Blind Holes (Studs, etc)
- Adjustment Screws
- Stripped Thread Repair

Thread Sealing

- Compression Fittings
- Flared / Swaged Fittings
- Hose Ends – Air & Hydraulic

Puncture Sealing

- Tanks, Vessels, etc

Porosity Sealing

- Porosity in Welds and Castings

Gasket Dressing

- Sealing Flanges with Gasket

Strengthen Keyed Assemblies

- Keyed Assemblies – Standard & Heavy Duty
- Repair Badly Wallowed Keys

Shaft Mounted Components

- Repair Badly Worn Shaft
- Slip Fit – Heavy Duty
- Press Fit

Housed Components

- Slip Fit – Light & Heavy Duty
- Retaining (Large Gaps)

And More....

Agency Approvals

Australian Gas Association (AGA)

Loctite® 55 - Approval number 6007 to 2400 kPa
Loctite® 510 - Approval number 2590 to 690 kPa
Loctite® 515 - Approval number 2590 to 690 kPa
Loctite® 567 - Approval number 3207 to 1050 kPa
Loctite® 569 - Approval number 3375 to 1050 kPa
Loctite® 577 - Approval number 4787 to 2600 kPa

Plumbing Safety License (AS/NZS 4020:2002)

Loctite® 55 - Certificate 8638
Loctite® 577 - Certificate 20079
Loctite® 680 - Certificate 8687

Australian Quarantine & Inspection Service (AQIS)

Loctite® Yuk-Off® Orange Hand Cleaner

NSF International

Loctite® 55 Pipe Sealing Cord
Loctite® 243 Threadlocker, Medium Strength/Oil Resistant
Loctite® 248 Threadlocker, Medium Strength/Removable
Loctite® 262 Threadlocker, Medium to High Strength
Loctite® 290 Threadlocker, Wicking Grade
Loctite® 480 Instant Adhesive, Black/Toughened
Loctite® 518 Gasket Eliminator™ Flange Sealant
Loctite® 561 PST™ Pipe Sealant
Loctite® 587 Blue, High Performance RTV Silicone Gasket Maker
Loctite® 680 Retaining Compound, Slip Fit/High Strength
Loctite® 5900 Flange Sealant, Heavy Body RTV Silicone
Loctite® 7649 Primer N
Loctite® Food Grade Anti-Seize
Loctite® No More Leaks, Plastic Pipe Sealant
Loctite® ODC-Free Cleaner & Degreaser

American Bureau of Shipping (ABS)

Loctite® 262 Threadlocker, Medium to High Strength
Loctite® 454 Instant Adhesive, Surface Insensitive Gel
Loctite® 567 PST™ Thread Sealant, High Temperature
Loctite® 587 Blue, High Performance RTV Silicone Gasket Maker
Loctite® 620 Retaining Compound, Slip Fit/High Temperature
Loctite® 680 Retaining Comp., Slip Fit/High Strength
Loctite® Extend® Rust Treatment
Loctite® Nickel Anti-Seize
Loctite® Silver Grade Anti-Seize

Canadian Food Inspection Agency (CFIA)

Loctite® 243 Threadlocker, Medium Strength/Oil Resistant
Loctite® 248 Threadlocker, Medium Strength/Removable
Loctite® 262 Threadlocker, Medium to High Strength
Loctite® 268 Threadlocker, High Strength
Loctite® 272 Threadlocker, High Strength/High Temperature
Loctite® 290 Threadlocker, Wicking Grade
Loctite® 330 Depend Adhesive, No Mix
Loctite® 454 Prism Instant Adhesive, Surface Insensitive Gel
Loctite® 518 Gasket Eliminator Flange Sealant
Loctite® 561 PST™ Pipe Sealant
Loctite® 567 PST™ Thread Sealant, High Temperature
Loctite® 569 Thread Sealant, Hydraulic Sealant
Loctite® 587 Blue, High Performance RTV Silicone Gasket Maker

Loctite® 609 Retaining Compound, Press Fit/General Purpose
Loctite® 620 Retaining Compound, Slip Fit/High Temperature
Loctite® 638 Retaining Compound, Slip Fit/Maximum Strength
Loctite® 641 Retaining Compound, Controlled Strength
Loctite® 660 Quick Metal Retaining Compound, Press Fit Repair
Loctite® 770 Primer
Loctite® 2760 Threadlocker, Primerless/High Strength
Loctite® 5900 Flange Sealant, Heavy Body RTV Silicone
Loctite® 7649 Primer N
Loctite® C5-A® Copper Based Anti-Seize
Loctite® Extend® Rust Treatment
Loctite® Form-A-Thread® Stripped Thread Repair Kit
Loctite® No More Leaks, Plastic Pipe Sealant
Loctite® O-Ring Making Kit
Loctite® Pipe Repair Kit

Canadian Food Inspection Agency (CFIA)

Loctite® Silver Grade Anti-Seize
Loctite® Superflex Red High Temp RTV, Silicone Adhesive Sealant
Loctite® Thread Sealant with PTFE

Military Specifications (Mil Spec)

Loctite® 262 Threadlocker, Medium to High Strength
Loctite® 277 Threadlocker, High Strength/Large Threads
Loctite® 290 Threadlocker, Wicking Grade
Loctite® 609 Retaining Compound, Press Fit/General Purpose
Loctite® 635 Retaining Compound, Slip Fit/High Strength/Slow Cure
Loctite® 640 Retaining Compound, Press Fit/Medium Strength/High Temp.
Loctite® 7452 Tak Pak Accelerator
Loctite® 7471 Primer T
Loctite® 7649 Primer N
Loctite® C5-A® Copper Based Anti-Seize
Loctite® Moly-50 Anti-Seize
Loctite® Silver Grade Anti-Seize

Military Specifications (Commercial Item Standard)

Loctite® 406 Instant Adhesive, Surface Insensitive

UL Classified/Listed for U.S.

Loctite® 55 Pipe Sealing Cord
Loctite® 271 Threadlocker, High Strength
Loctite® 510 Gasket Eliminator™ Flange Sealant
Loctite® 515 Gasket Eliminator™ Flange Sealant
Loctite® 561 PST™ Pipe Sealant
Loctite® 567 PST™ Thread Sealant, High Temperature
Loctite® 587 Blue, High Performance RTV Silicone Gasket Maker

ULC Classified for Canada

Loctite® 561 PST™ Pipe Sealant
Loctite® 567 PST™ Thread Sealant, High Temperature

CSA International

Loctite® 55 Pipe Sealing Cord
Loctite® 561 PST™ Pipe Sealant
Loctite® 567 PST™ Thread Sealant, High Temperature

Fluid Compatability Chart

GASES

Perchloric Acid	□	Potassium Permanganate	●	Sodium Benzene Sulfonate	●	Sulfathiazole	●	Udylite Bath-Nickel	●	Acetylene	●
Perchloromethyl Mercaptan	●	Potassium Persulfate	●	Sodium Bichromate	●	Sulfite Liquor	●	Undecylenic Acid	●	Acid & Alkali Vapors	●
Permanganic Acid	✘	Potassium Phosphate	●	Sodium Bisulfite	●	Sulfite Stock	●	Unichrome Sol. Alk.	●	Air	●
Persulfuric Acid	✘	Potassium Silicate	●	Sodium Bromide	●	Sulfonated Oils	●	Uranium Salts	●	Amine	●
Petroleum Ether	●	Potassium Sulfate	●	Sodium Carbonate	●	Sulfones	●	Uranyl Nitrate	●	Ammonia	●
Petroleum Jelly	●	Potassium Xanthate	●	Sodium Chlorate	●	Sulfonic Acids	●	Uranyl Sulfate	●		
Phenol Formaldehyde Resins	●	Press Board Waste	●	Sodium Chlorite	●	Sulfonyl Chloride	●	Urea Ammonia Liquor	●	Butane	●
Phenol Sulfonic Acid	●	Propionic Acid	●	Sodium Cyanide	●	Sulfur Slurry	●			Butadiene Gas/Liquid	●
Phenolic Glue	●	Propyl Alcohol	●	Sodium Ferricyanide	●	Sulfur Solution	●			Butylene Gas/Liquid	●
Phloroglucinol	●	Propyl Bromide	●	Sodium Formate	●	in Carbon Disulfide	●			By-Product Gas (Dry)	●
Phosphate Ester	●	Propylene Glycol	●	Sodium Glutamate	●			Vacuum to 100 Micron	●		
Phosphatic Sand	●	Pumice	●	Sodium Hydrogen Sulfate	●			Vacuum below 100 Micron	↑		
Phosphoric Acid 85% (hot)	✘	Pyranol	●	Sodium Hydroxide	●	Sulphuric Acid 0-7%	↑	Vacuum Oil	●	Carbon Dioxide	●
Phosphoric Acid 85% (cold)	↑	Pyridine	●	Sodium Hydroxide	●	Sulphuric Acid 7-40%	↑			Carbon Disulfide	●
Phosphoric Acid 50% (hot)	↑	Pyrogallol Acid	●	Sodium Hydrochloride	●	Sulphuric Acid 40-75%	↑			Carbon Monoxide	●
Phosphoric Acid 50% (cold)	↑	Pyrogen Free Water	●	Sodium Hydroxide	✘	Sulphuric Acid 75-95%	✘			Chloride (Dry)	●
Phosphoric Acid 10% (cold)	●	Pyrole	●	Sodium Hydro. 20% (cold)	●	Sulphuric Acid 95-100%	✘			Chlorine (Dry)	✘
Phosphoric Acid 10% (hot)	↑	Pyromellitic Acid	●	Sodium Hydro. 20% (hot)	↑	Sulphurous Acid	↑			Chlorine (Wet)	✘
Phosphorous Molten	●			Sodium Hydro. 50% (cold)	↑	Sulfonyl Chloride	●			Coke-Oven Gas (Cold)	●
Phosphotungstic Acid	●	Quebracho Tannin	●	Sodium Hydro. 50% (hot)	✘	Surfactants	●			Coke-Oven Gas (Hot)	↑
Photographic Sol.	●			Sodium Hydro. 70% (cold)	↑	Synthetic Latex	●			Cyanogen Chloride	●
Phthalic Acid	●	Rag Stock Bleached	●	Sodium Hydro. 70% (hot)	✘	Taconite-Fines	●			Cyanogen Gas	●
Phytate	●	Rare Earth Salts	●	Sodium Hypochlorite	●	Talc-Slurry	●				
Phytate Salts	●	Rayon Acid Water	●	Sodium Lignosulfonate	●	Tankage-Slurry	●			Ethane	●
Pickling Acid, Sulfuric	●	Rayon Spin Bath	●	Sodium Metasilicate	●	Tannic Acid (cold)	↑			Ether-see Diethyl Ether	●
Picric Acid Solutions	●	Resorcinol	●	Sodium Molten	●	Tamin	●			Ethylene	●
Pine Oil Finish	●	River Water	●	Sodium Nitrate	●	Tar & Tar Oil	●			Ethylene Oxide	●
Plating Sol. as follows:		Road Oil	●	Sodium Nitrite-Nitrate	●	Tartaric Acid	●				
Brass Cyanide	●	Rosin	●	Sodium Perborate	●	Television Chemicals	●	Water-Acid – Below pH7	●		
Bronze-Cyanide	●	Rosin-Wood	●	Sodium Peroxide	✘	Tergitol S	●	Water pH7 to 8	●	Freon § (11-12-21-22)	↑
Chromium & Cadmium	●	Rosin in Alcohol	●	Sodium Persulfate	●	Terpineol	●	Water Alkaline – Over pH8	●	Furnace Gas (Cold)	↑
Cyanide	●	Rubber Latex	●	Sodium Phosphate-Mono	●	Tetraethyl Lead	●	Water Mine Water	●	Furnace Gas (Hot)	●
Cobalt Acid	●			Sodium Phosphate-Tri	●	Tetrahydrofuran	●	Water Potable	◇		
Copper Acid	●			Sodium Phosphate-Tri	●	Tetranitromethane	●	Water River	●	Gas Drip Oil	●
Copper Alk.	●			Sodium Potassium Chloride	●	Textile Dyeing	●	Water Sandy	●	Gas Flue	●
Gold Cyanide	●	Safrole	●	Sodium Salicylate	●	Textile Finishing Oil	●	Water "White" – low pH	●	Gas Manufacturing	●
Iron-Acid	●	Salt Alkaline	●	Sodium Sesquicarbonate	●	Textile Printing Oil	●	Water "White" – high pH	●	Gas Natural	●
Lead-Fluoro	●	Salt Electrolytic	●	Sodium Silicate	●	Thiocyanic Acid	●	Wax	●		
Nickel Bright	●	Salt Refrg.	●	Sodium Silicofluoride	●	Thiogycollic Acid	●	Wax Chlorinated	●	Helium	●
Platinum	●	Sand-Air Blown Slurry	●	Sodium Stannate	●	Thionyl Chloride	●	Wax Emulsions	●	Hydrogen Gas – Cold	●
Silver-Cyanide	●	Sand-Air Phosphatic	●	Sodium Sulfate	●	Thiophosphoryl Chloride	●	Weed Killer Dibromide	●	Hydrogen Chloride	●
Tin-Acid	●	Sea Coal	●	Sodium Sulfite	●	Thiourea	●	Weisberg Sulfate Plating	●	Hydrogen Cyanide	●
Tin Alk. Barrel	●	Sea Water	●	Sodium Sulfite	●	Thorium Nitrate	●	Wood ground pulp	●	Hydrogen Sulfide – Wet & Dry	●
Zinc Acid	●	Selenium Chloride	●	Sodium Sulfhydrylate	●	Thymol	●	Wort Lines	●		
Zinc Alk. Cyanide	●	Sequestrene	●	Sodium Thiocyanate	●	Tin Tetrachloride	●			Isobutane	●
Polyacrylonitrile Slurry	●	Seaweed	●	Sodium Thiosulfate	●	Tin Tinning Sol. DuPont	●			Methane	●
Polyepentek	●	Shellac	●	Sodium Tungstate	●	Titanium Paper Coating	●	X-Ray Developing Bath	●	Methyl Chloride	●
Polymer Sulfide Liquor	●	Shower Water	●	Sodium Xanthate	●	Titanium Oxide Slurry	●	Xylene	●		
Polyvinyl Acetate Slurry	●	Silica Gel	●	Solox-Denat. Ethanol	●	Titanium Oxy Sulfate	●			Natural Gas – Dry	●
Polyvinyl Chloride	●	Silica Ground	●	Soluble Oil	●	Titanium Sulfate	●	Zelan	●	Nitrogen Gas	●
Porcelain Frit	●	Silicone Tetrachloride	●	Solvent Naphthas	●	Titanium Tetrachloride	●	Zeolite Water	●	Nitrous Oxide	●
Potash	□	Silicone Fluids	●	Sorbic Acid	●	Toluol	●	Zinc Acetate	●		
Potassium Acetate	●	Silver Cyanide	●	Sour Gasoline	●	Toluene	●	Zinc Bromide	●	Oil-Solvent Vapor	●
Potassium Alum. Sulfate	●	Silver Iodide-Aqu.	●	Soybean Sludge-Acid	●	p-Toluene Sulfonic Acid	↑	Zinc Chloride	●	Oxygen	✘
Potassium Bromide	●	Silver Nitrate	●	Spensol Solution	●	Transil Oil	●	Zinc Cyanide-Alk.	●	Ozone	✘
Potassium Carbonate	●	Size Emulsion	●	Stannic Chloride	●	Trichloroacetic Acid	●	Zinc Fines Slurry	●		
Potassium Chlorate	●	Skelly Solve E. L	●	Starch	●	Trichlorethane 1,1,1	●	Zinc Flux Paste	●	Producer Gas 50 PSI	●
Potassium Chloride Sol.	●	Slate to 400 Mesh	●	Starch Base	●	Trichlorethylene	●	Zinc Galvanizing	●	Propane	●
Potassium Chromate	●	Soap Lye	✘	Stearic Acid	●	Trichlorethylene-Dry	●	Zinc Hydroxulfite	●	Propylene	●
Potassium Cyanide Sol.	●	Soap Solutions (Stearates)	●	Steep Water	●	Tricresyl Phosphate	●	Zinc Oxide in Water	●		
Potassium Dichromate	●	Soap Stone Air Blown	●	Sterilization Steam	●	Triethanolamine	●	Zinc Oxide in Oil	●	Steam High Pressure (70 psi)	✘
Potassium Ferricyanide	●	Soda Pulp	●	Stillage Distillers	●	Triethylene Glycol	●	Zinc Sulfate	●	Steam Low Pressure (70 psi)	●
Potassium Hydroxide	✘	Sodium Acetate	●	Stoddard Solvent	●	Trioxane	●	Sulfur Dioxide	●	Sulfur Dioxide Dry	●
Potassium Iodide	●	Sodium Aluminate	●	Styrene	●	Tungstic Acid	●	Sulfur Trioxide	●	Sulfur Trioxide Gas	✘
Potassium Nitrate	●	Sodium Arsenate	●	Styrene Butadiene Latex	●	Turpentine	●	Sulfuric Acid Vapor	●		
Potassium Perchlorate	●			Sulfamic Acid	●	UCON § Lube	●				
				Sulfan-Sulfuric Anhydride	●						

- NOTE: 1. The above information does not constitute a recommendation of sealant use. It is intended only as a guide for consideration by the purchaser with the expectation of favorable confirming test results. It is impossible to test sealant reaction with the multitude of chemicals in existence, therefore, compatibility has been estimated based on a wide variety of customer experience.
2. With the stringent action of such chemicals as Freon §, strong cold acids and caustics, thorough evaluation is suggested. Sealing of hot corrosive chemicals is not recommended.
3. Contact Henkel Corporation for use with chemicals not covered by this information.

§ Listing(s) may be Brand Name(s) or Trademarks for chemicals of Corporations other than Henkel. Freon is a reg. trademark of E.I. DuPont de Numours, Co., Inc.

Loctite® product numbers in red are worldwide or application-specific products.

(This is a list of chemical stability only. It does not constitute approval for use in the processing of foods, drugs, cosmetics, pharmaceuticals, and ingestible chemicals.) Loctite® sealants are not recommended for use in pure oxygen or chlorine environments or in conjunction with strong oxidising agents, an explosive reaction can result.

The data contained herein are furnished for information only and are believed to be reliable. We cannot assume responsibility for the results obtained by others over whose methods we have no control. It is the user's responsibility to determine suitability for the user's purpose of any production methods mentioned herein and to adopt such precautions as may be advisable for the protection of property and of persons against any hazards that may be involved in the handling and use thereof.

In light of the foregoing, HENKEL CORPORATION SPECIFICALLY DISCLAIMS ALL WARRANTIES OF MERCHANTABILITY OR FITNESS FOR A PARTICULAR PURPOSE ARISING FROM SALE OR USE OF HENKEL CORPORATION'S PRODUCTS. HENKEL

CORPORATION SPECIFICALLY DISCLAIMS ANY LIABILITY FOR CONSEQUENTIAL OR INCIDENTAL DAMAGES OF ANY KIND, INCLUDING LOST PROFITS. The discussion herein of various processes or compositions is not to be interpreted as a representation that they are free from domination of patents owned by others or as a license under any HENKEL CORPORATION patents which may cover such processes or compositions. We recommend that each prospective user test the proposed application to determine its suitability for the purposes intended prior to incorporation to determine its suitability for manufacturing process using this data as a guide. This product may be covered by one or more United States or foreign patents or patent application.





Henkel – Your partner worldwide

www.loctite.com.au
www.loctite.co.nz

Visit the web for
immediate access to:

- Technical Data Sheets*
- Material Safety Data Sheets*
- Product Literature*
- Product Application Assistance*
- New Product Information & News*

Henkel Australia Pty. Ltd.
135-141 Canterbury Road,
Kilsyth, Victoria, 3137
Phone: 1300 88 555 6
www.loctite.com.au

Henkel New Zealand Ltd.
PO Box 58 493
Greenmount 1730
Auckland, New Zealand
Phone: (64) 09/272 6710
Orders Fax: (64) 09/272 6711
www.loctite.co.nz

The data contained herein are furnished for information only and are believed to be reliable. We cannot assume responsibility for the result obtained by others over whose methods we have no control. It is the user's responsibility to determine suitability for the user's purpose of any production methods mentioned herein and to adopt such precautions as may be advisable for the protection of property and persons against any hazards that may be involved in the handling and use thereof. The discussion herein of various processes or compositions is not to be interpreted as representation that they are free from patents owned by others or as a licence under any Henkel patents which may cover such processes or compositions. We recommend that each prospective user test his proposed application before repetitive use, using this data as a guide.

Gasket Eliminator™ and PST™ are trademarks, Loctite®, Chisel®, Maxx®, Yuk-Off®, Natural Blue® Extend® and Form-A-Thread® are Registered Trade Marks of Henkel Corporation, USA.
©Copyright 4/07, Henkel Australia Pty. Ltd. All rights reserved. ART0761

IDH471670001012